

Coloring &
Activity
BOOK

United States Postal Service

© 2000 United States Postal Service
Publication 39, Coloring & Activity Book

For more information on stamps and stamp collecting, go to the
USPS website at www.stampsonline.com.

William J. Henderson, Postmaster General and Chief Executive Officer
Azeezaly S. Jaffer, Vice President, Public Affairs and Communications
James C. Tolbert Jr., Manager, Stamp Services



Design by Jill Tanenbaum Graphic Design & Advertising, Inc.



United States Postal Service

Coloring Activity Book

Get ready to blast off! Your journey into stamp collecting is about to begin. Take a look. You'll learn about all kinds of things you're interested in—especially with these out-of-this-world stamps celebrating spaceflight.

Mars Rover Sojourner

\$ 3 00
usa

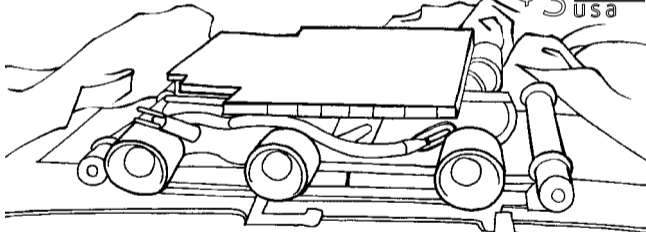



Mar

tian Madness

Here's a message written in Martian. Can you read it?
Use the secret code. Find the symbol on the code that looks like the one in the message. See the letter next to the symbol?
Write that letter under the symbol. When you have written all the letters, you can read what the Martians wrote.

						
a	b	c	d	e	f	
						
g	h	i	j	k	l	
						
m	n	o	p	q	r	s
						
t	u	v	w	x	y	z

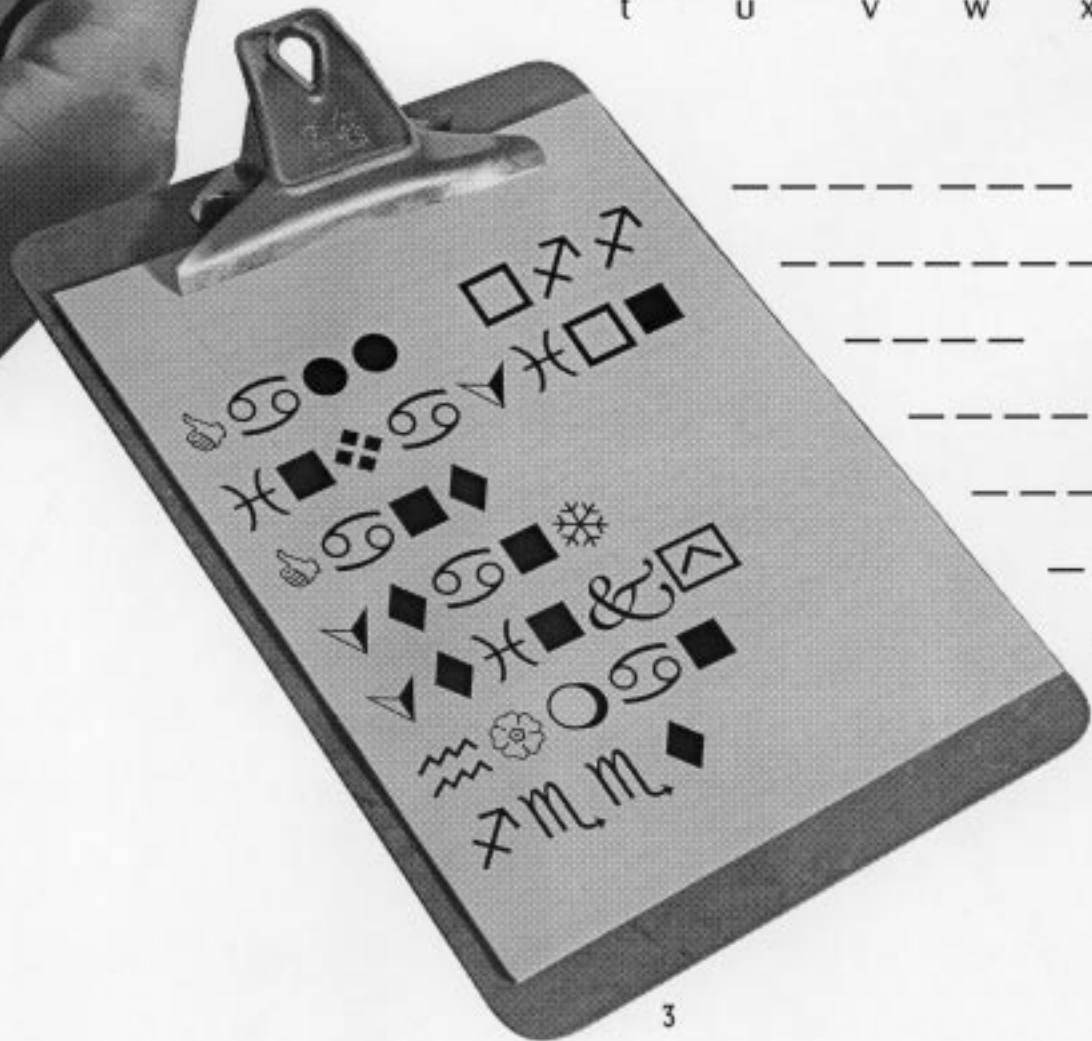

USA
\$2.40

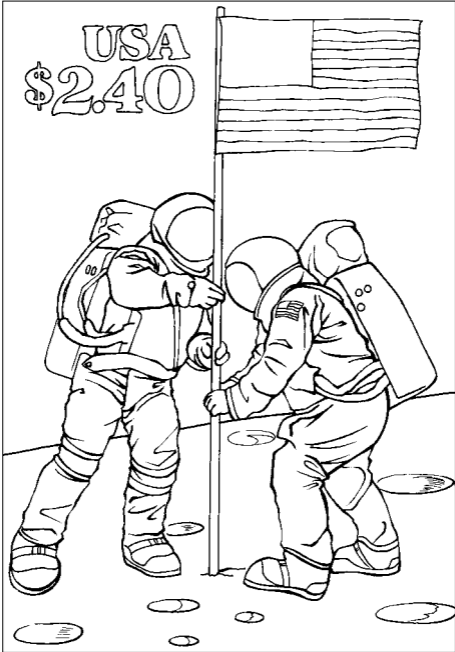

Triangle Trek

Use the same color to color in all of the areas that have exactly three sides. Buckle your seat belt!

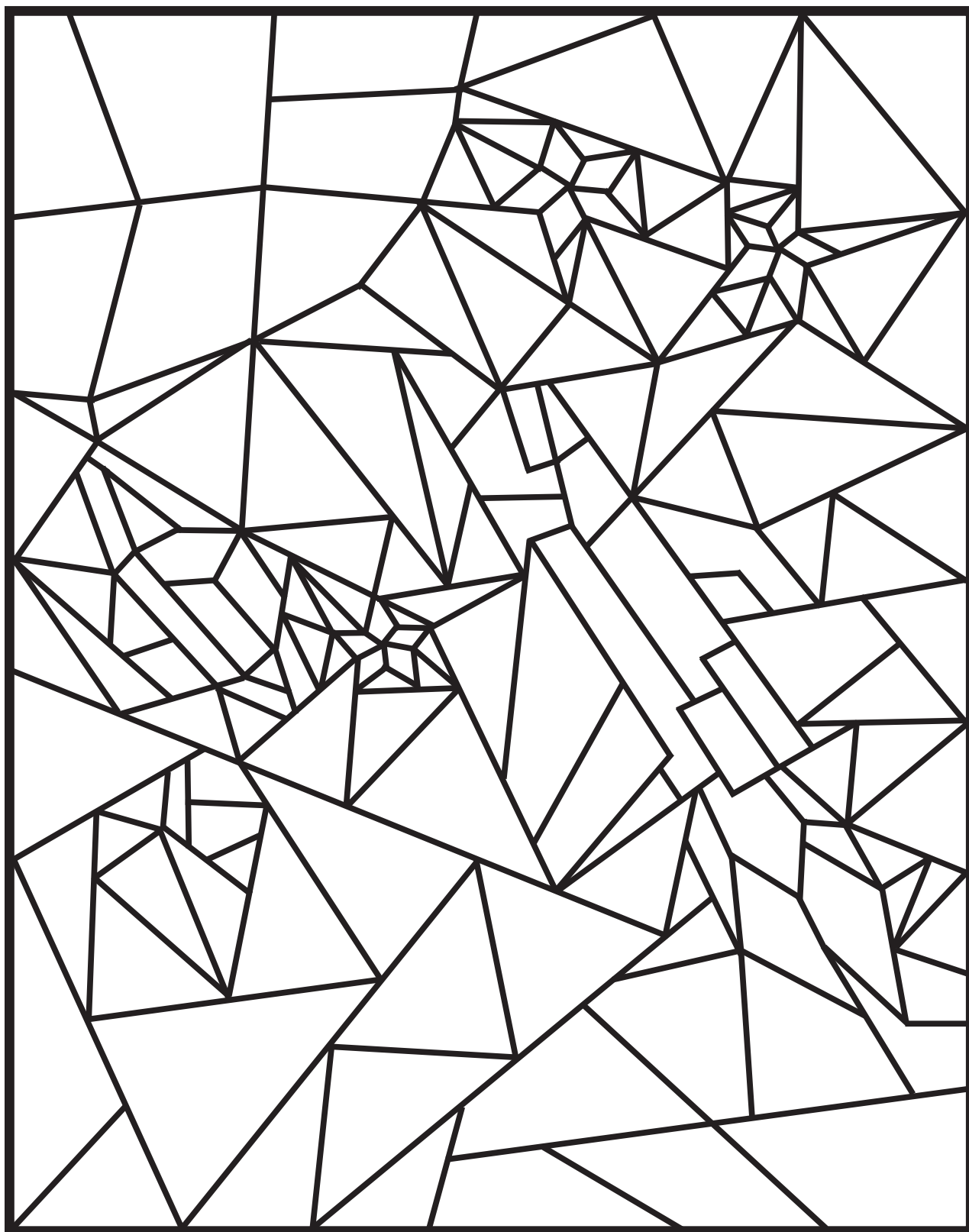

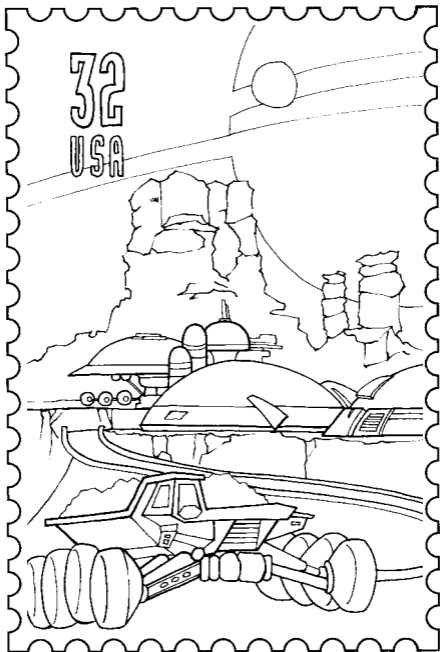



Connect the dots to make a constellation.
This constellation is an animal. Can you tell what kind?

What's Your Constellation?

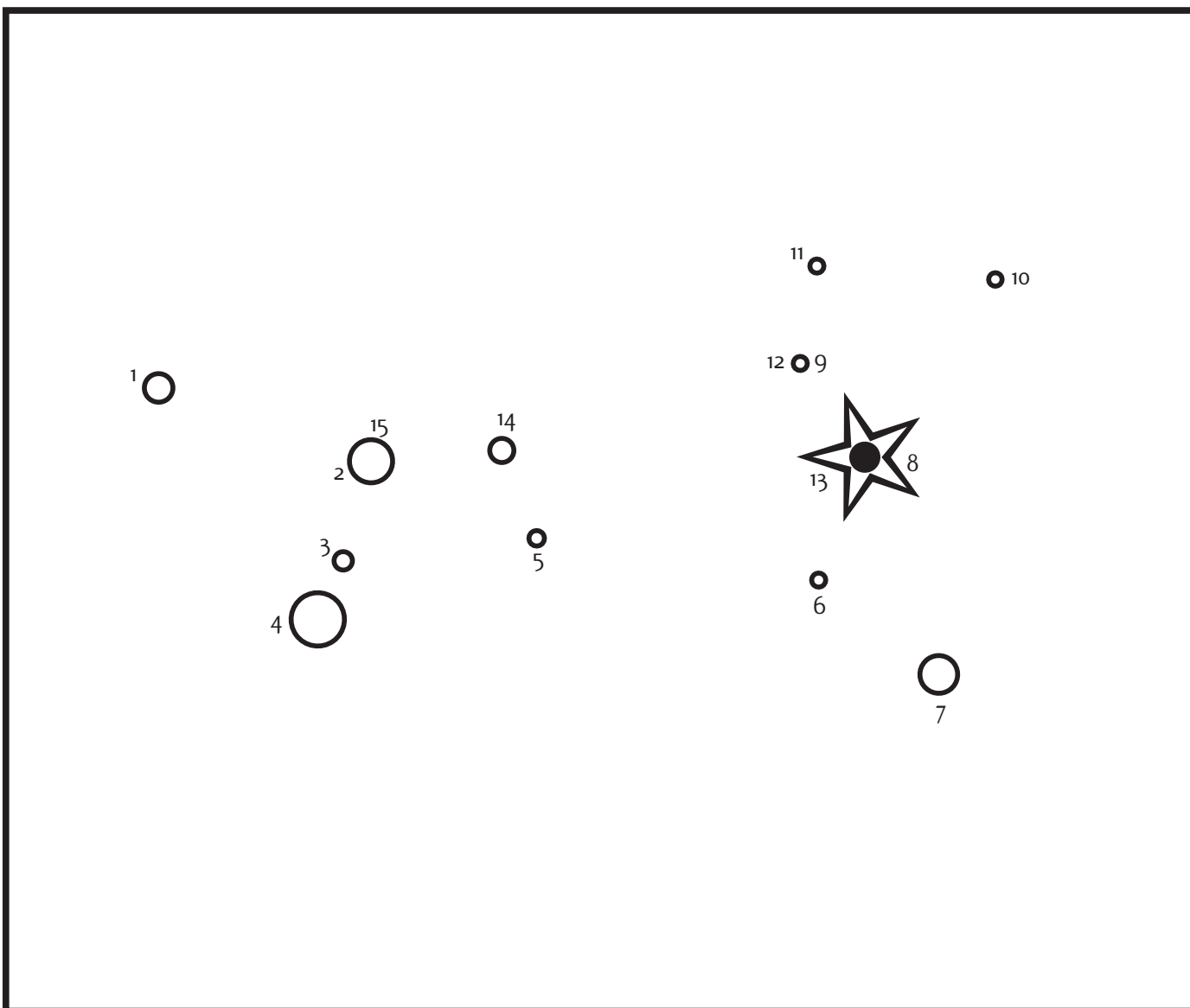

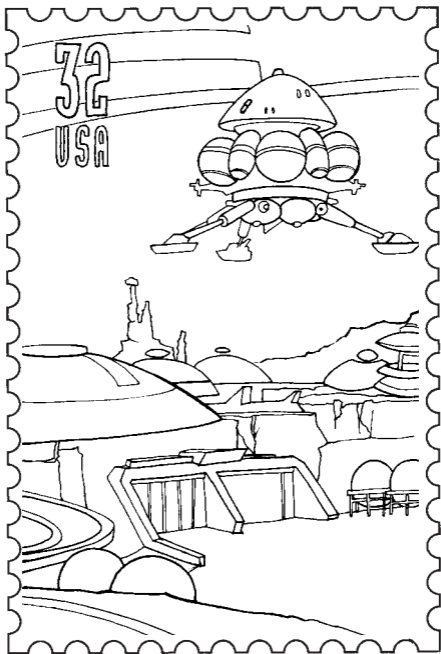

Twin Aliens

Even aliens from the same planet don't always look alike. These aliens look similar, but only two look exactly the same. Can you pick the two that match?

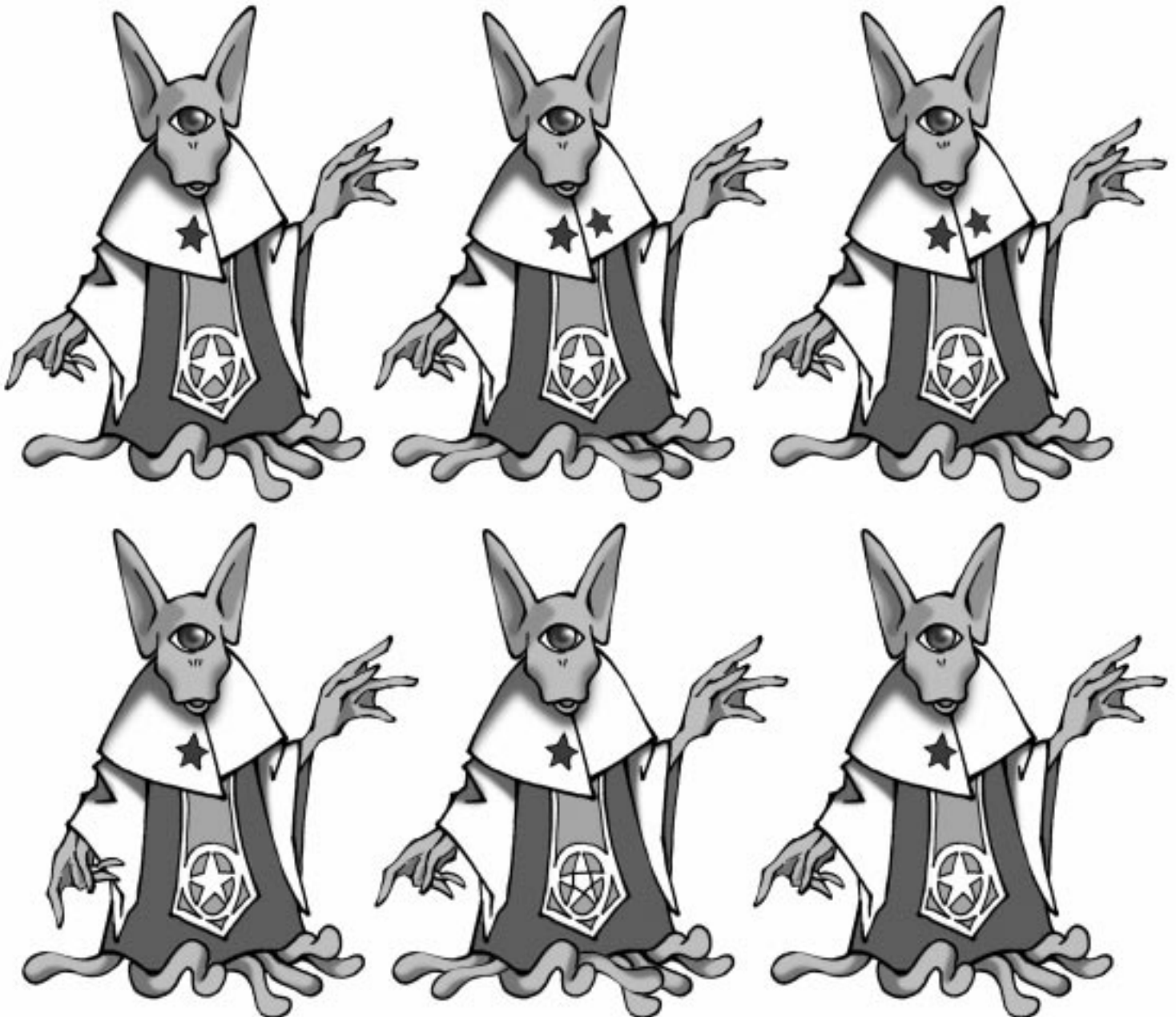

USA 18c

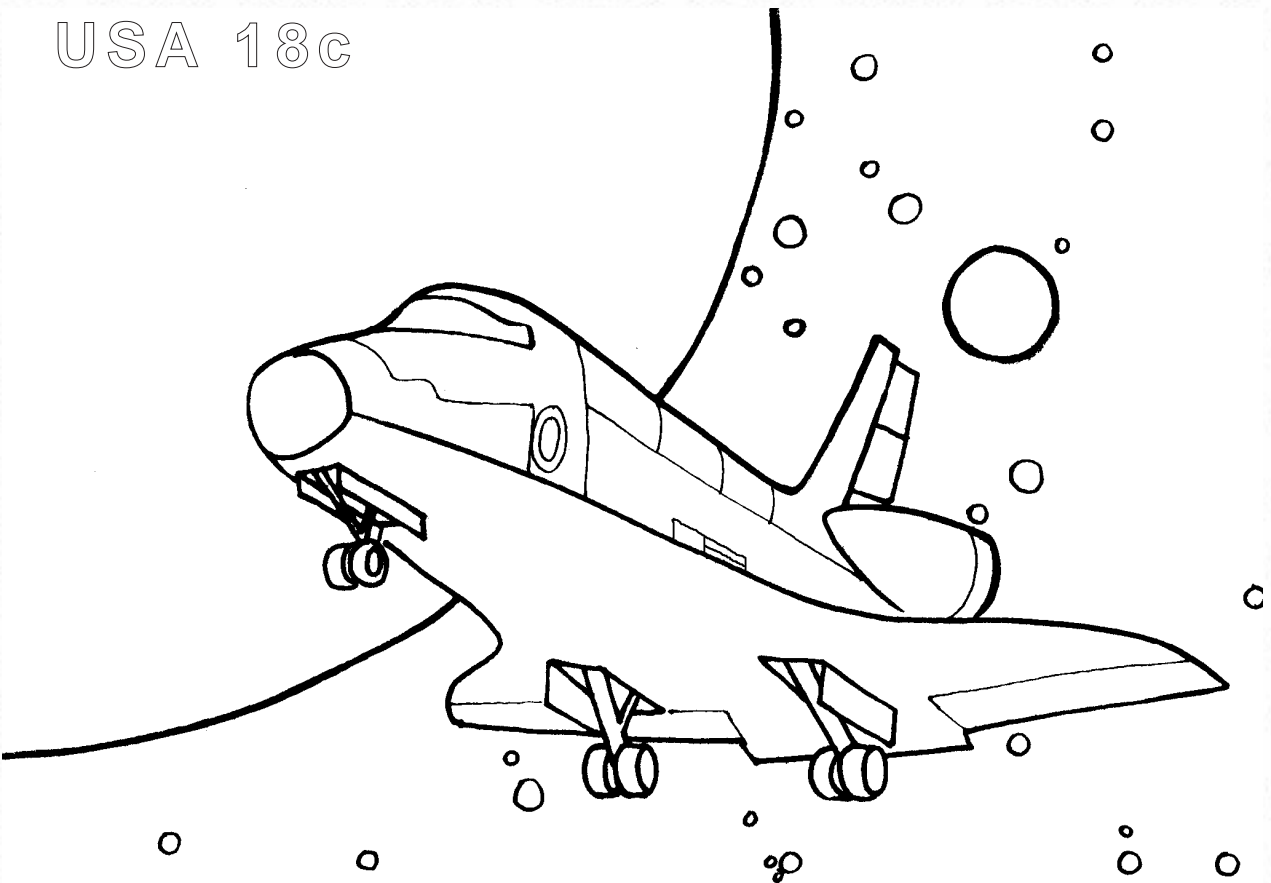

Benefiting Mankind

Monitor Mishaps

The computer has been malfunctioning lately. All the words come out scrambled.
Can you unscramble the letters to read the message?

**MI RYOSR DREIFN,
I TPU MJA NI
RYUO MSEJIMA.**

- - - - -

USAirmail

45

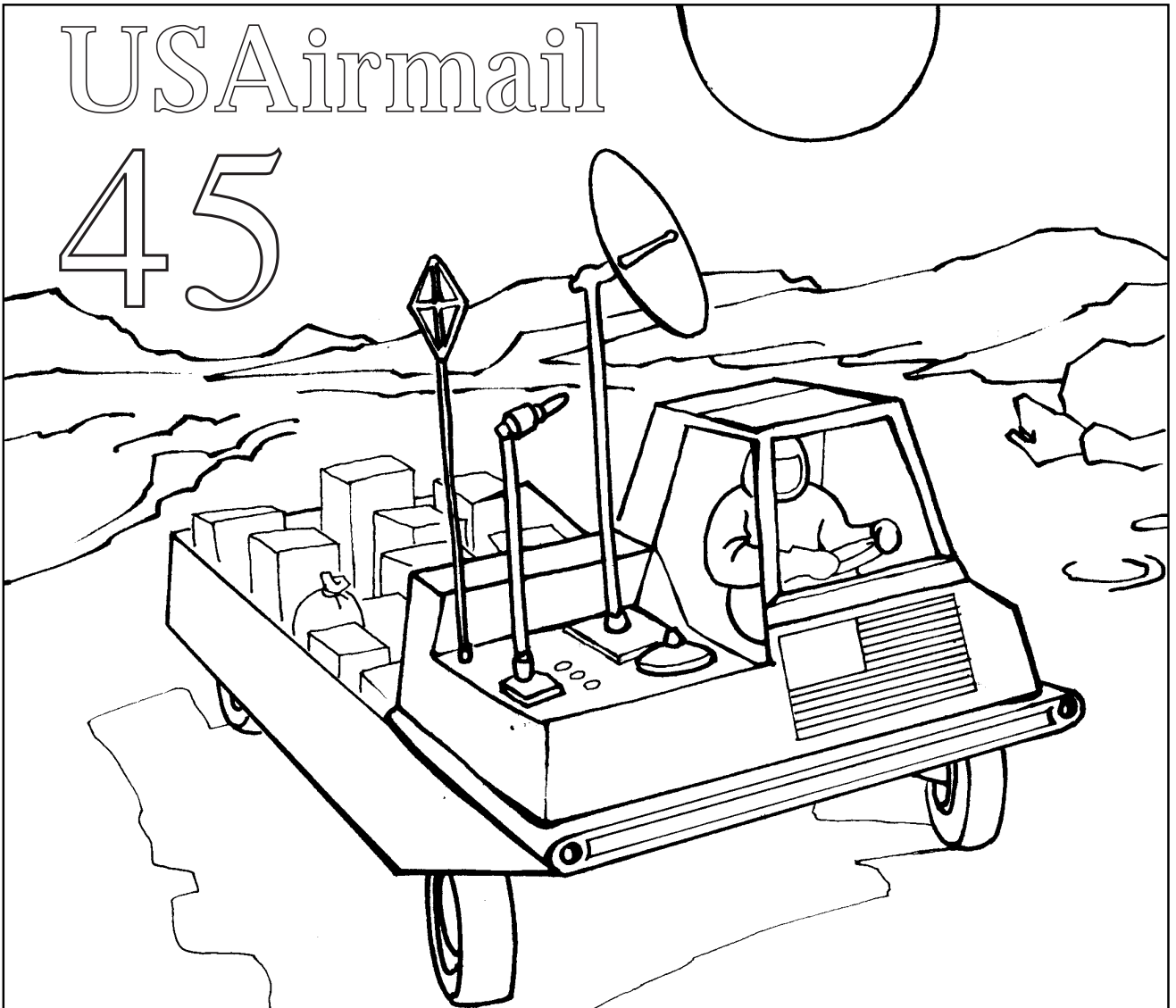

20th Universal Postal Congress

Robbie the Robot is caught in a time warp. He has a message to help him get back to the 21st century, but there are at least 22 words from the wrong time period. Can you find them all?

Ye Olde Time Warp

Verily, the key to finding thy way back home is in seeing whence you came. Look thither and you and soon you'll see a yellow line down the midst of a brick road. Follow it anon until ye see a door to a livery where deliveries are made. Knock thrice and ask the yeoman there to give you a map. The map consisteth of a series of byways that run to different time periods. Spy the road marked "2000" and leave forthwith. On the way ye will meet a knave who may try to purloin your map. Hie quickly away until you reach a door with a portcullis. There thou wilt find the exit you seek.



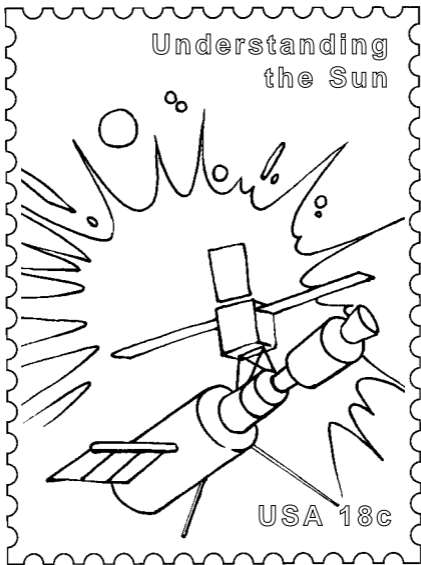

Fantastic Plastic

All the words in this crossword puzzle are made of a space-age substance known as plastic.

DOWN

- 1- You drink your juice through this
- 2- This keeps you dry in the rain
- 3- How you measure things
- 4- How you fasten your shirt
- 5- What you take hot soup to school in
- 6- This keeps your hair neat
- 7- A fun board game
- 8- You keep a sandwich in this

ACROSS



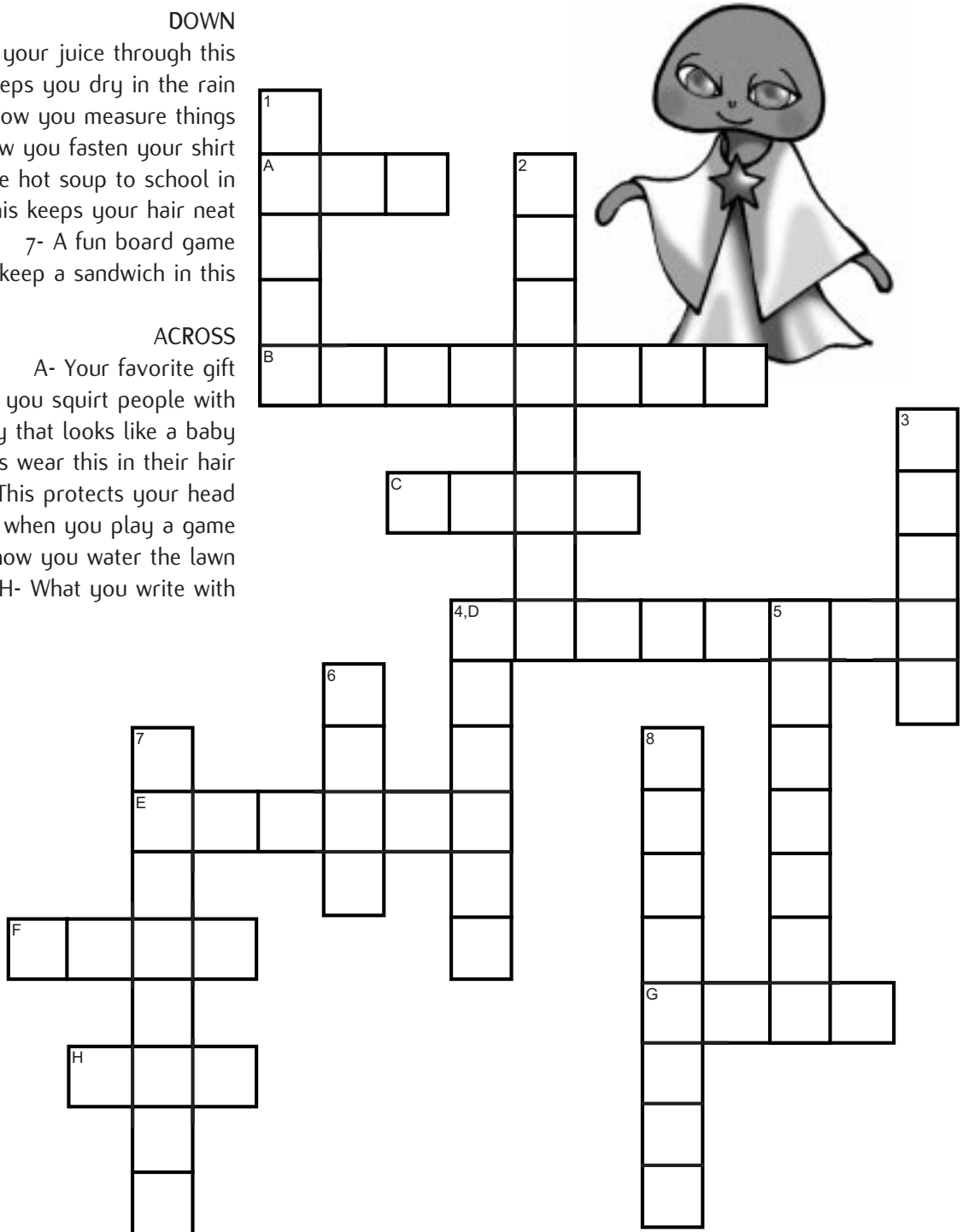

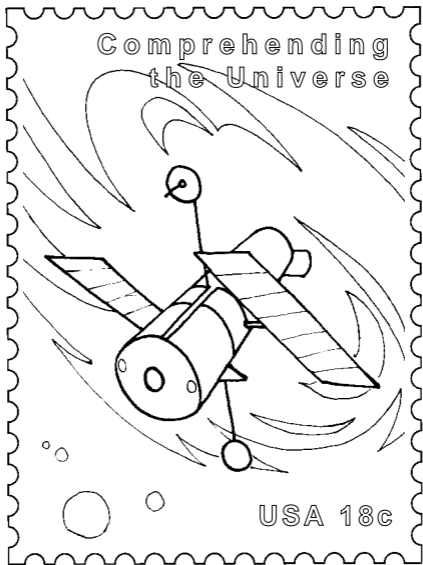
- A- Your favorite gift
- B- What you squirt people with
- C- A toy that looks like a baby
- D- Girls wear this in their hair
- E- This protects your head
- F- You roll them when you play a game
- G- This is how you water the lawn
- H- What you write with







Rocket Rebuses





NASA needs your help to find two of its space exploration vehicles. First identify each picture below. Then spell out each word and add and subtract the letters as shown. If you do it correctly, you'll find the missing items.

 +
 
 +
 
 +
 



s _ _ _ _ + a _ _ _ _ + h _ _ _ + r _ _ _ _

- 
 - 
 = _ _ _ _ _

e _ _ - r _ _ _ =



 +
 
 +
 
 +
 

m _ _ _ + r _ _ _ _ + t _ _ _ _ + m _ _ _ _

- 
 - 
 = _ _ _ _ _

t _ _ _ - t _ _ _ _ =

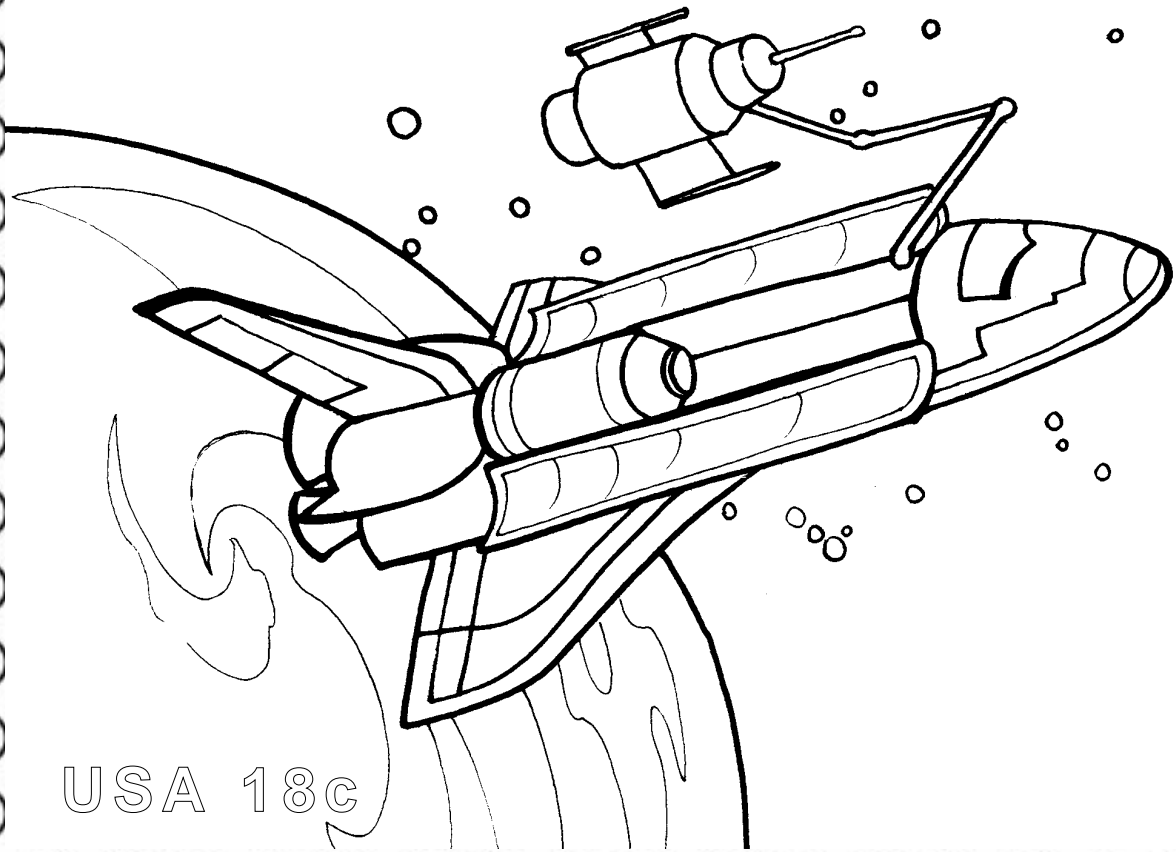
Benefiting Mankind



USA 18c

Revealing Missions

Hidden in the grid are 13 names from the U.S. and Russian space programs.

Can you find them all? Look across, back, down, up, and diagonally to discover them.

The word VOYAGER has been circled as an example.

R	E	D	N	I	F	H	T	A	P
O	V	E	R	G	N	I	K	I	V
N	R	F	Z	T	E	Y	A	J	O
R	E	N	R	U	O	J	O	S	Y
B	N	P	I	N	Y	L	D	A	A
A	I	B	M	U	L	O	C	O	G
L	R	E	G	O	R	U	S	K	E
Y	A	M	P	I	O	N	E	E	R
K	M	A	T	L	A	N	T	I	S
S	P	U	T	N	I	K	C	G	O

VOYAGER
 SOJOURNER
 MIR
 APOLLO
 COLUMBIA
 PIONEER
 VIKING
 SOYUZ
 ATLANTIS
 MARINER
 PATHFINDER
 SPUTNIK
 SKYLAB

You can also find
 5 words that the
 astronauts might say
 during space flights:

ROGER
 OVER
 A-OK
 GO
 DA

(Russian for "Yes")



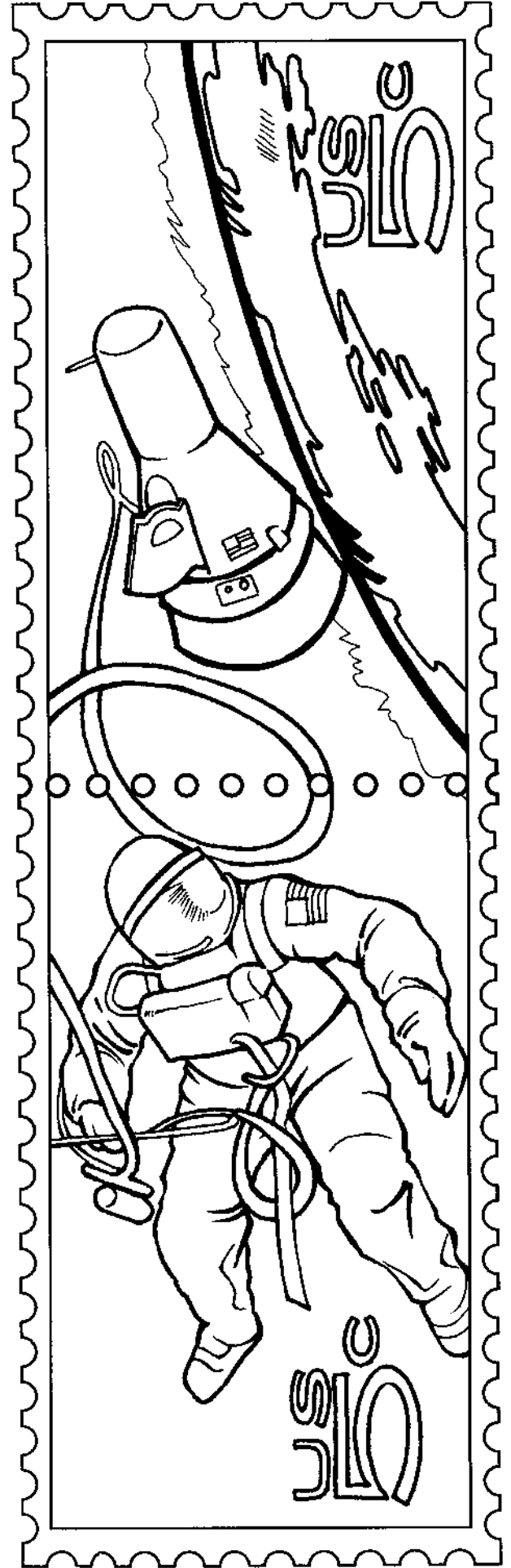
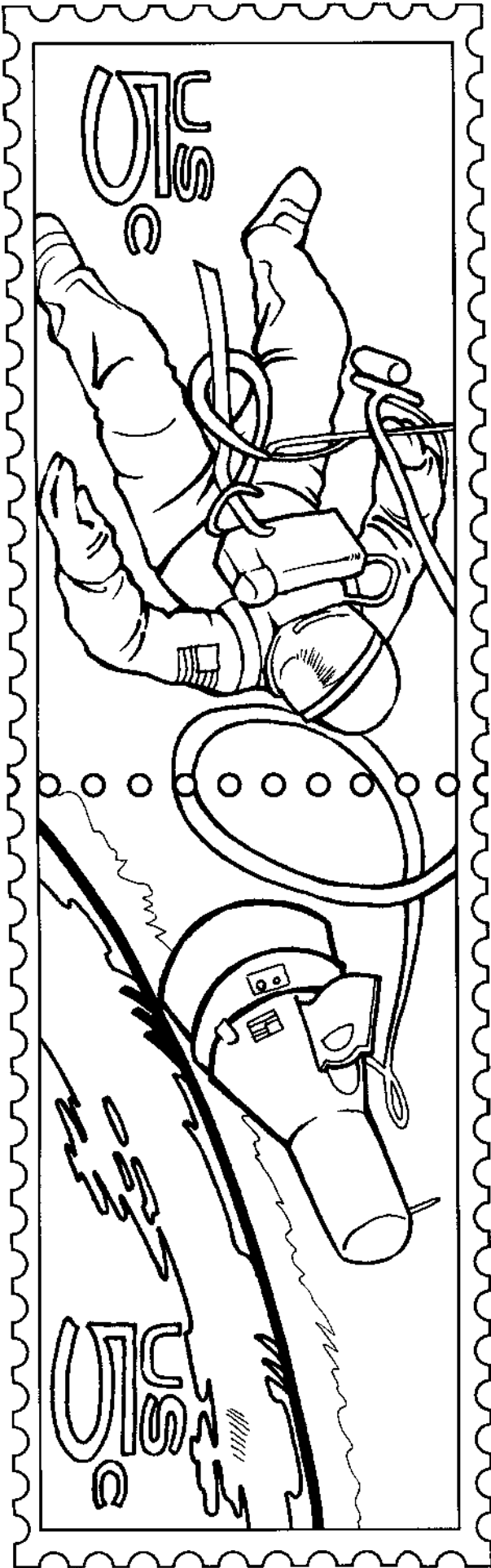



Alien Odyssey

Can you help the extraterrestrial find his space ship?

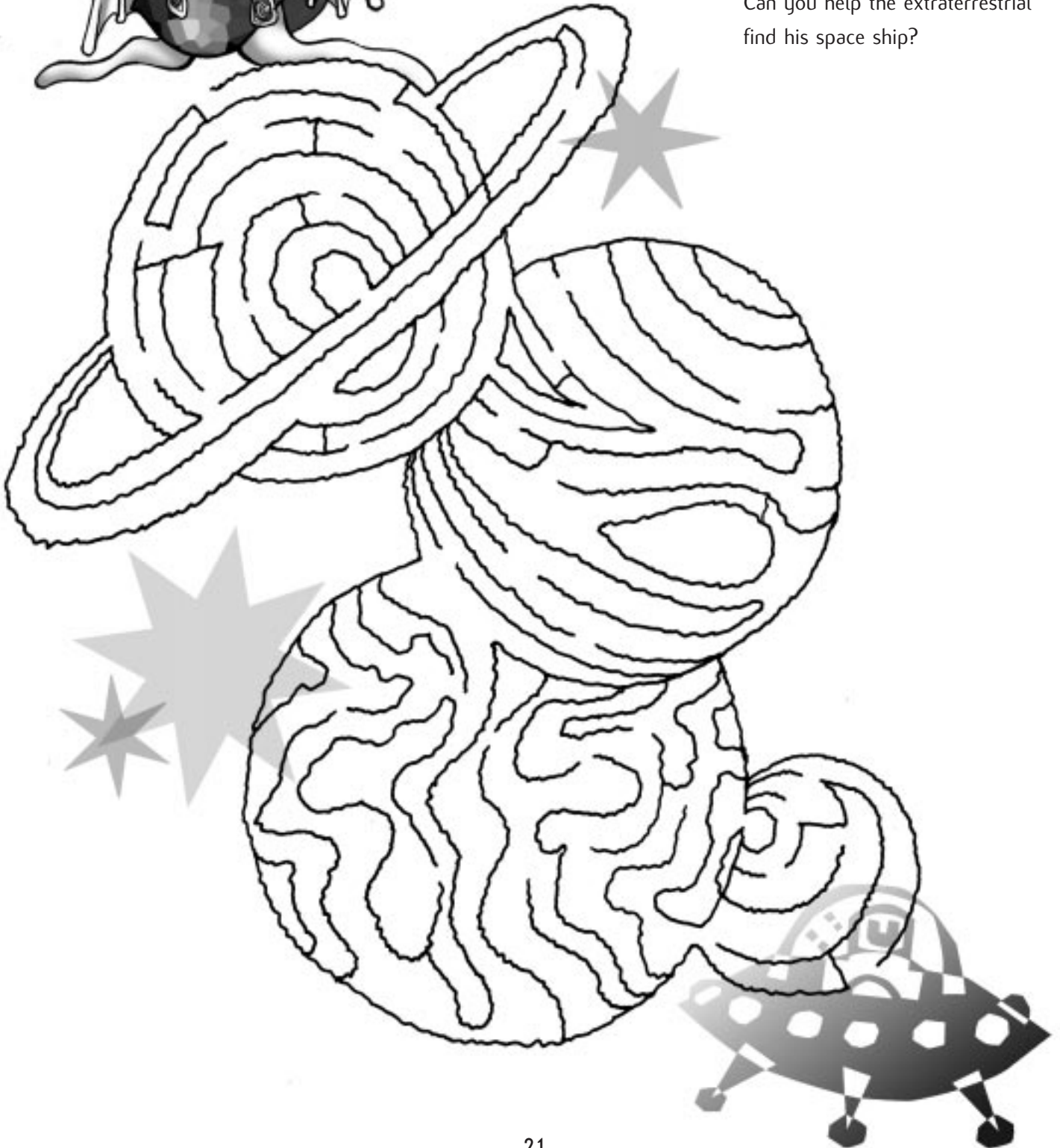

USAirmail

45

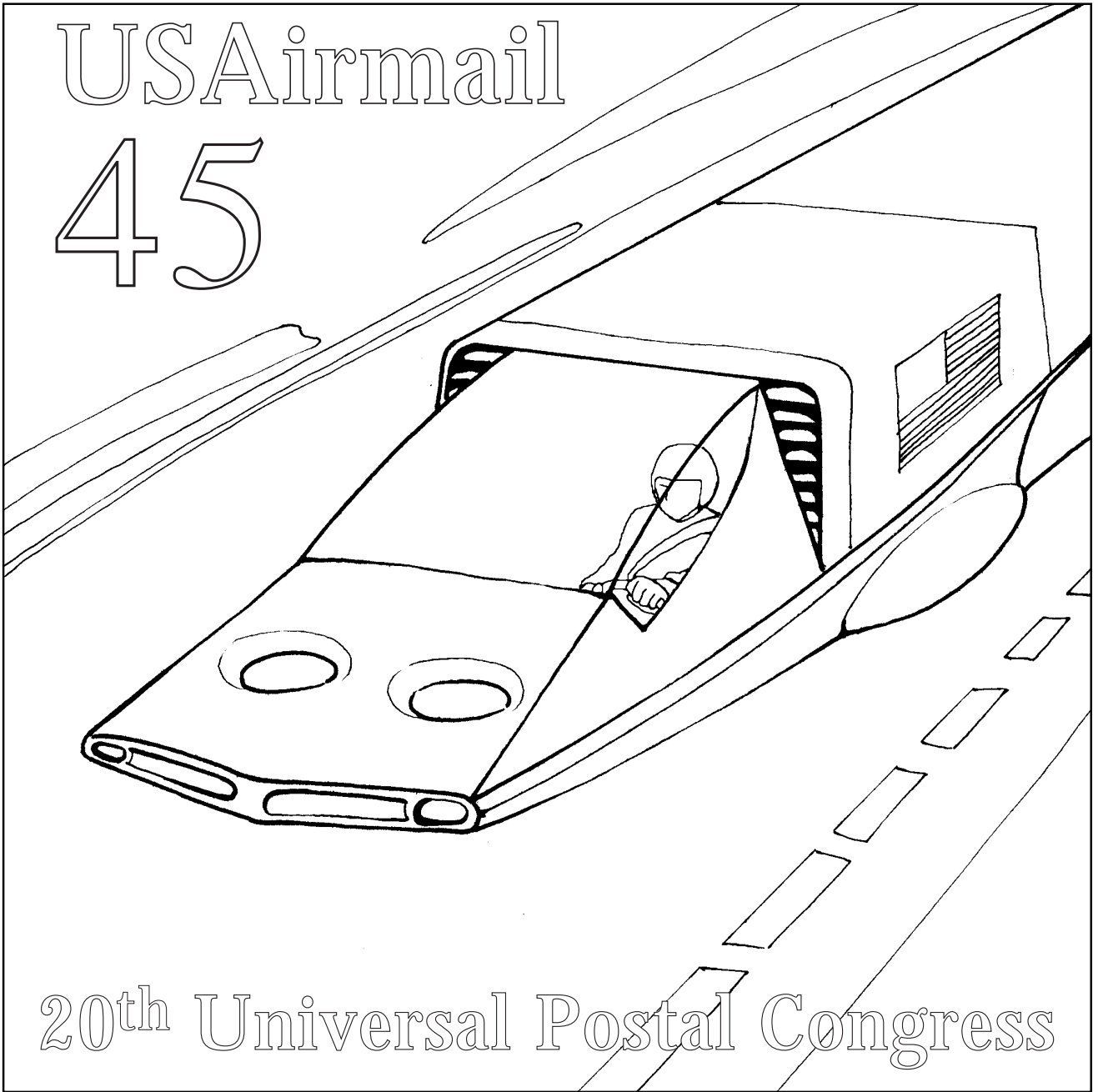

20th Universal Postal Congress

A Moon's Eye View

In 1989, 20 years after astronauts first landed on the moon, the United States Postal Service issued a new moon stamp, which is shown at the right. From the moon, the astronauts had a great view of the Earth. On the map below, can you identify the Earth's continents that the astronauts saw? Match the letters appearing next to the continent names with the continents in the picture.

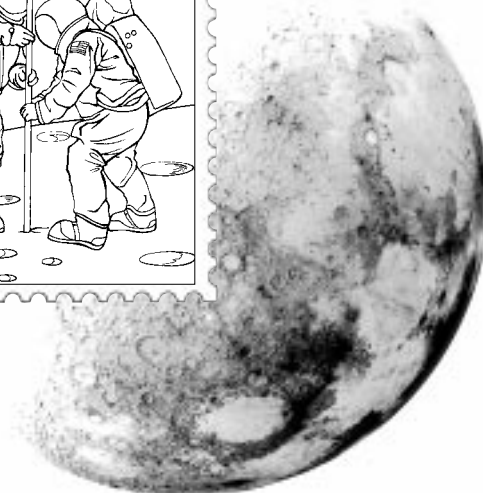
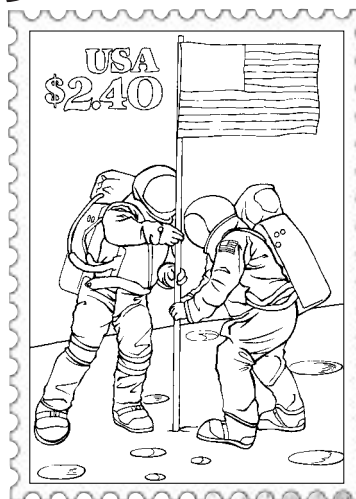

- | | | | |
|---|---------------|---|------------|
| A | Africa | E | Europe |
| B | North America | F | Australia |
| C | Asia | G | Antarctica |
| D | South America | | |

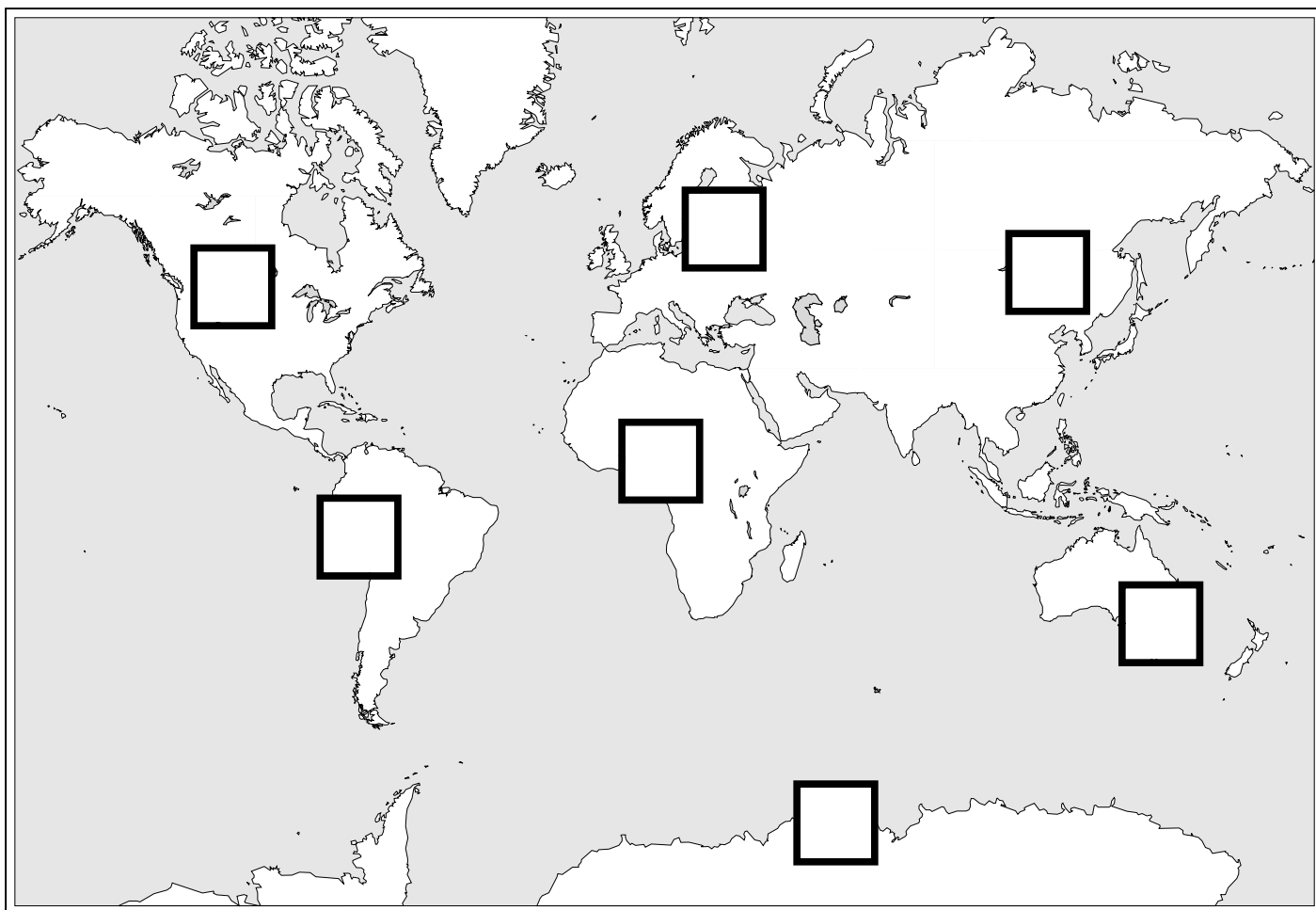

USAirmail

45

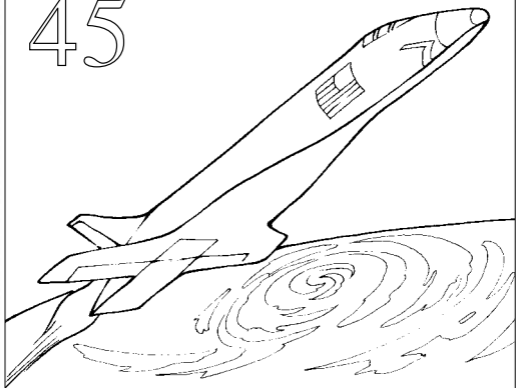

20th Universal Postal Congress

The Mailmen in the Moon

In 1969, when the astronauts in Apollo 11 traveled to the moon, they took with them a “moon letter” with a 10¢ stamp. That letter traveled almost a half million miles, farther than any letter had ever traveled.

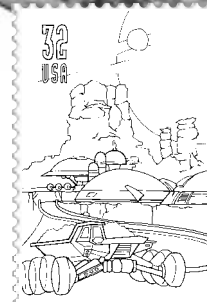
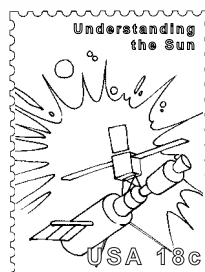
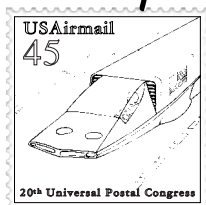
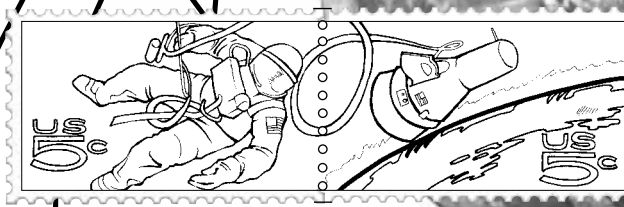

Now it's time to mail your own letter to the moon. The postage for this long journey is only \$1.43. If you can use only 5 stamps above, which ones would you need to have the exact postage?

$$\underline{\quad} \text{¢} + \underline{\quad} \text{¢} + \underline{\quad} \text{¢} + \underline{\quad} \text{¢} + \underline{\quad} \text{¢} = \$1.43$$



USAirmail

45

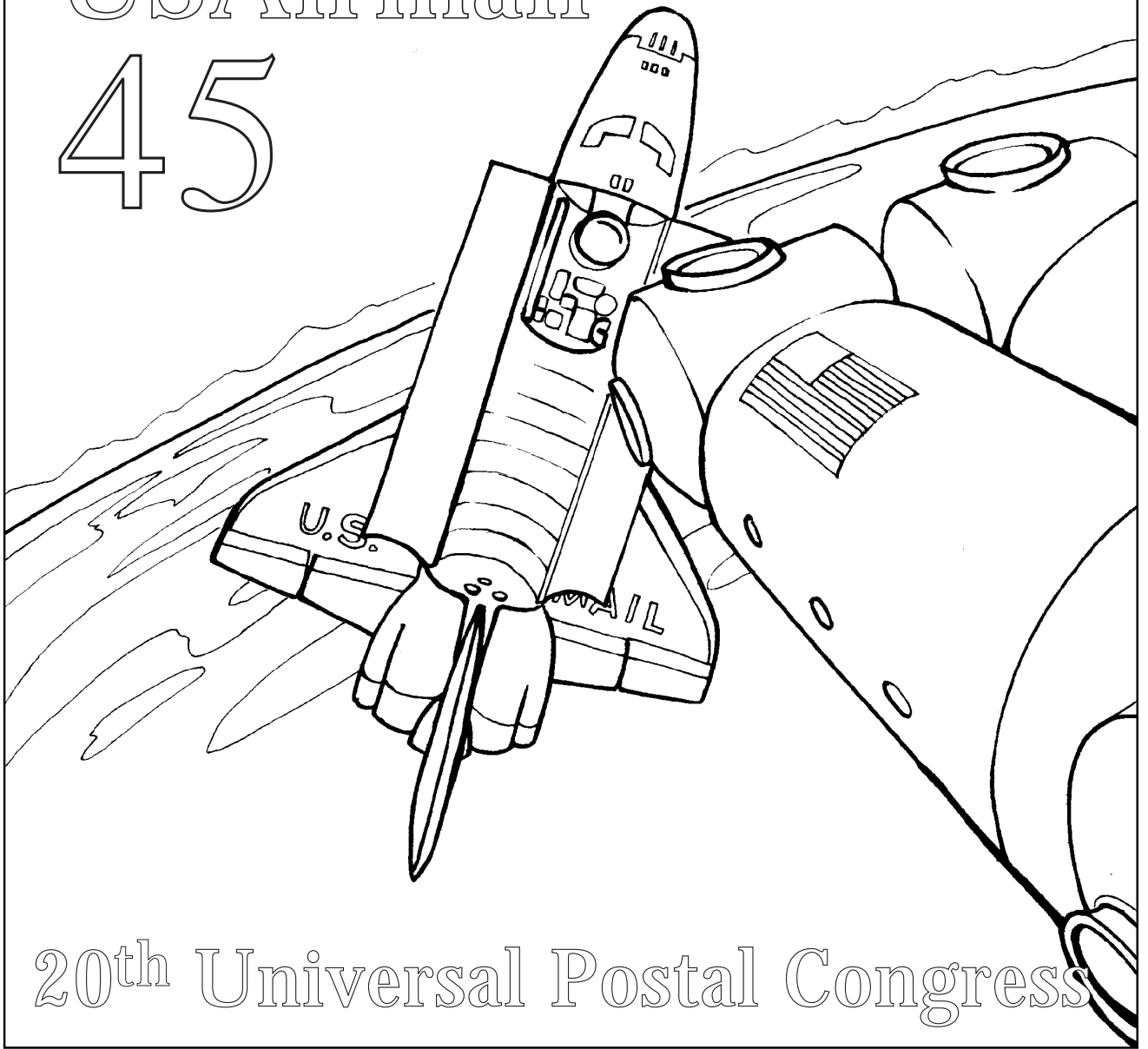

20th Universal Postal Congress

Project Picture



If you were a futuristic letter carrier, what would your route look like? Pick one of the futuristic mail delivery vehicles shown in the stamps to the left and draw a scene in the square below. Whom would you deliver to? Would there be houses? What would their mailboxes look like?



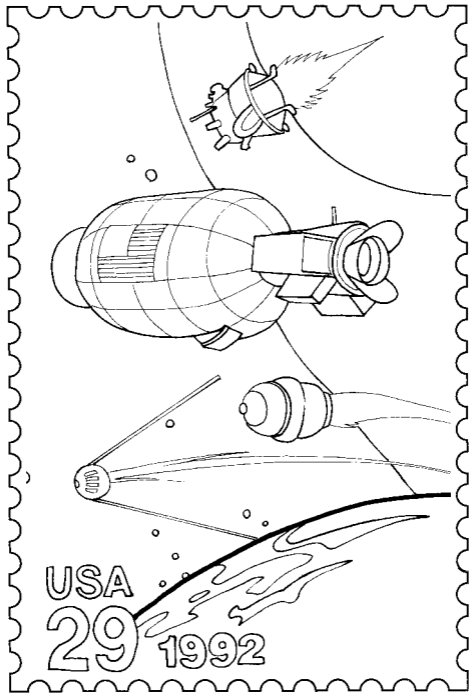

Out of Orbit

Here are pictures of stamps showing the planets and the various spacecraft that have explored them. There is also a drawing of the planets, but all their names are scrambled, so the spacecraft are getting lost. Can you help them find the right planets and complete their missions by unscrambling the planet names?

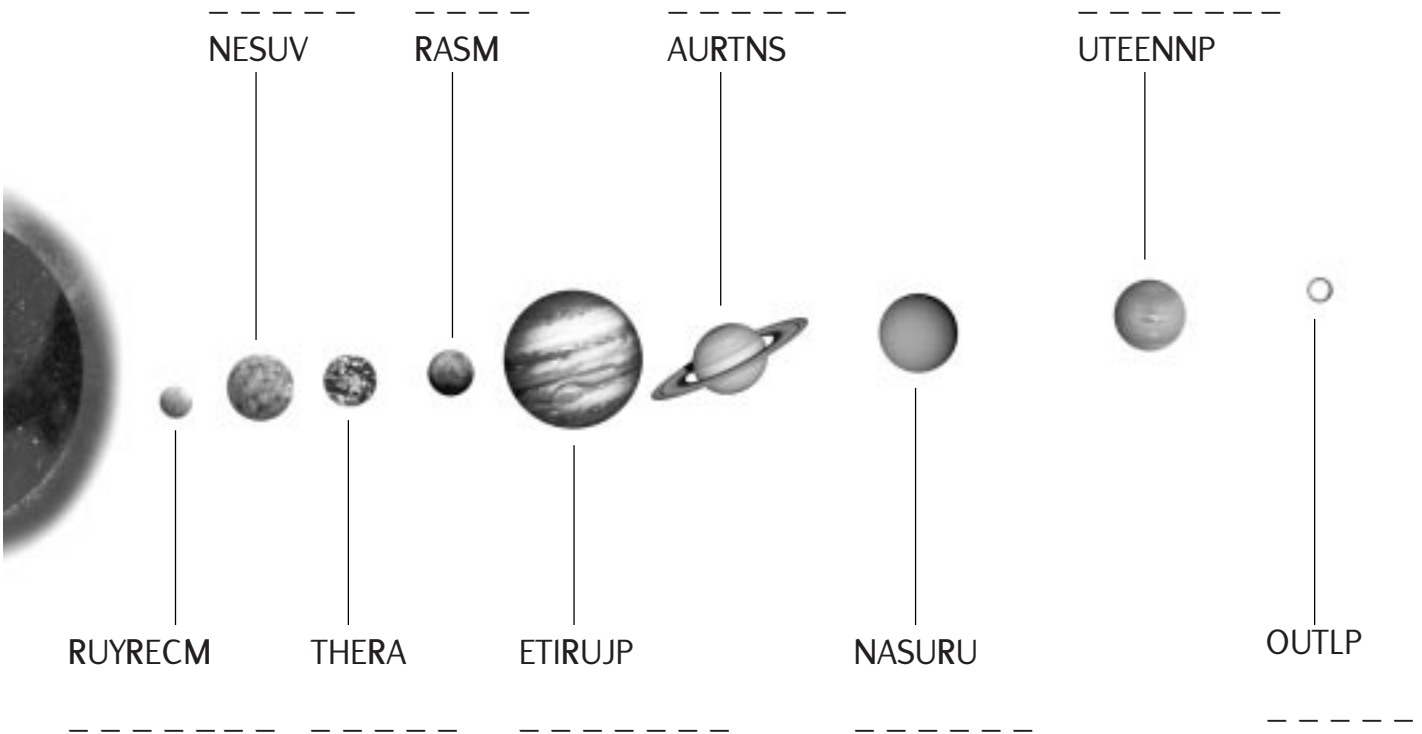

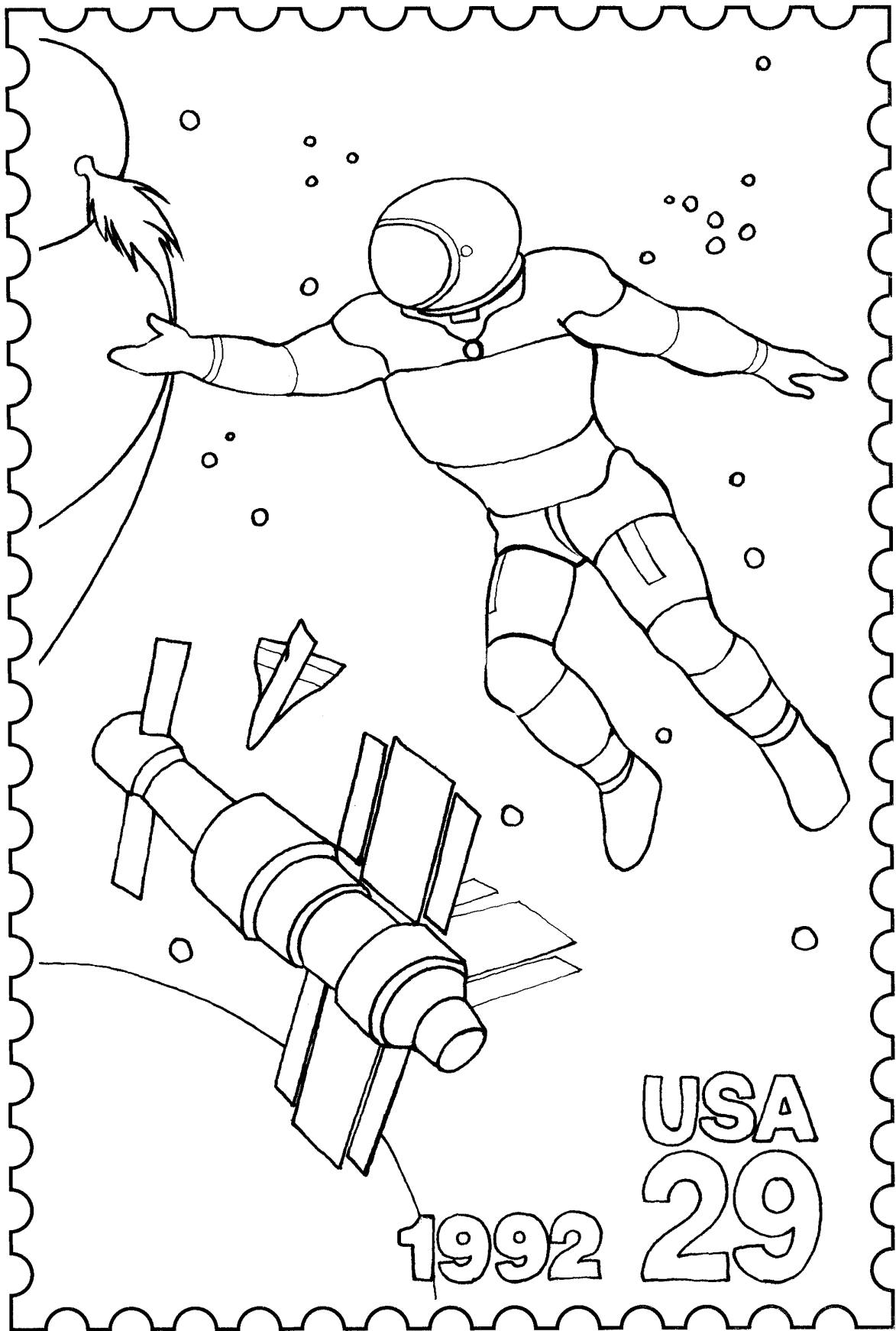

Design Your Own Stamps!

On this page and the following blank pages, use your imagination to create special stamps that you'd like to see.

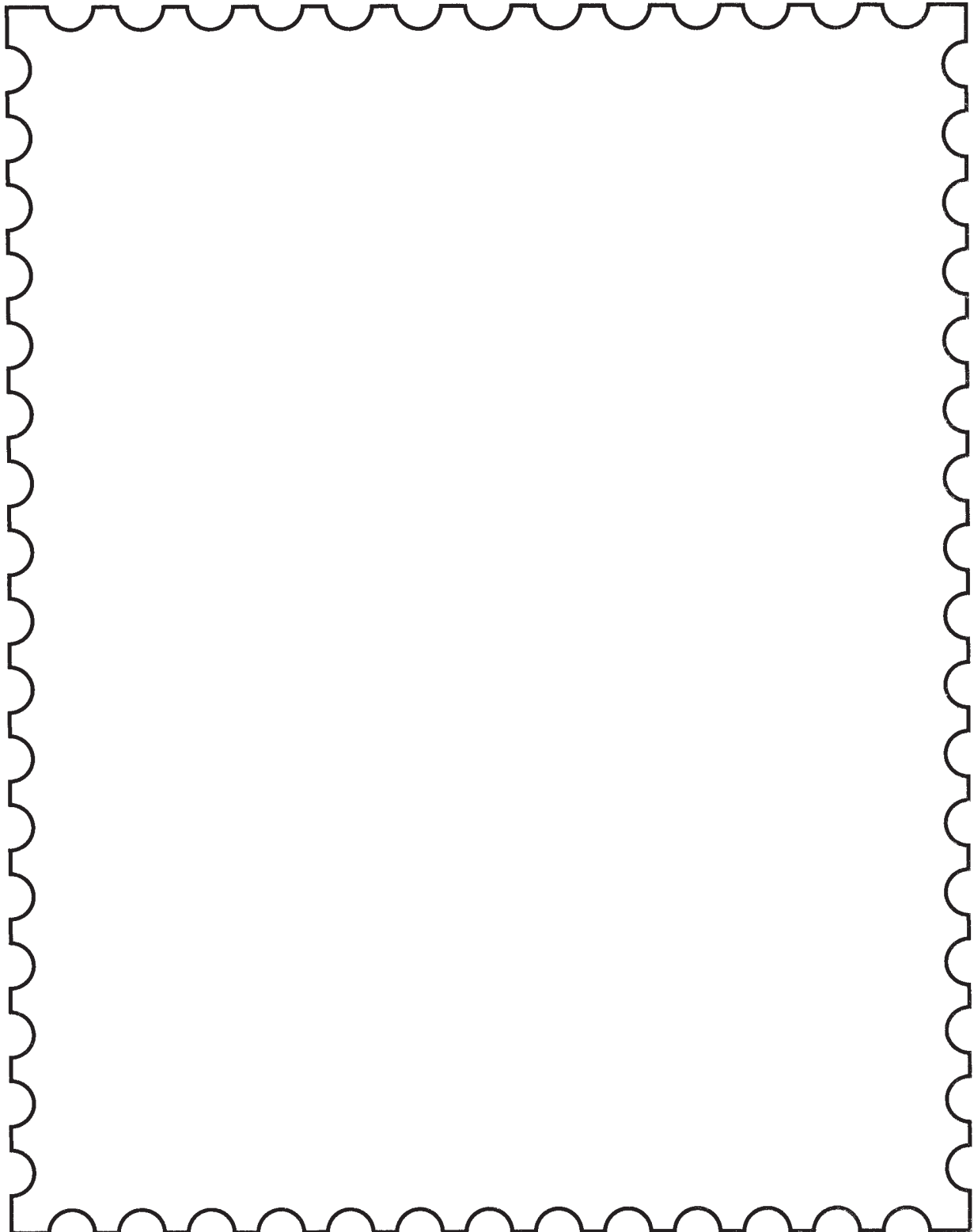

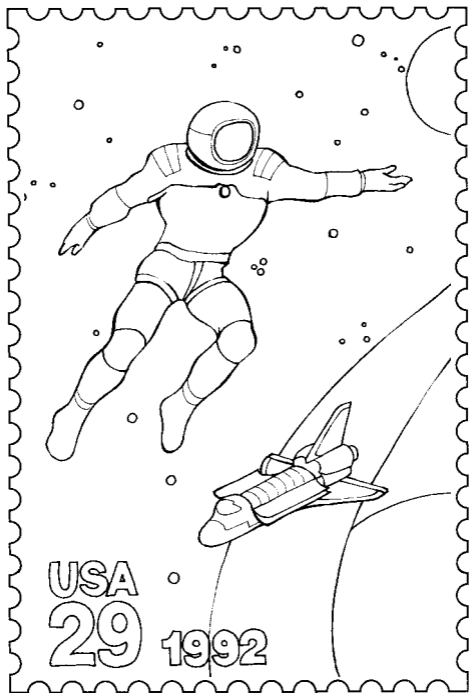

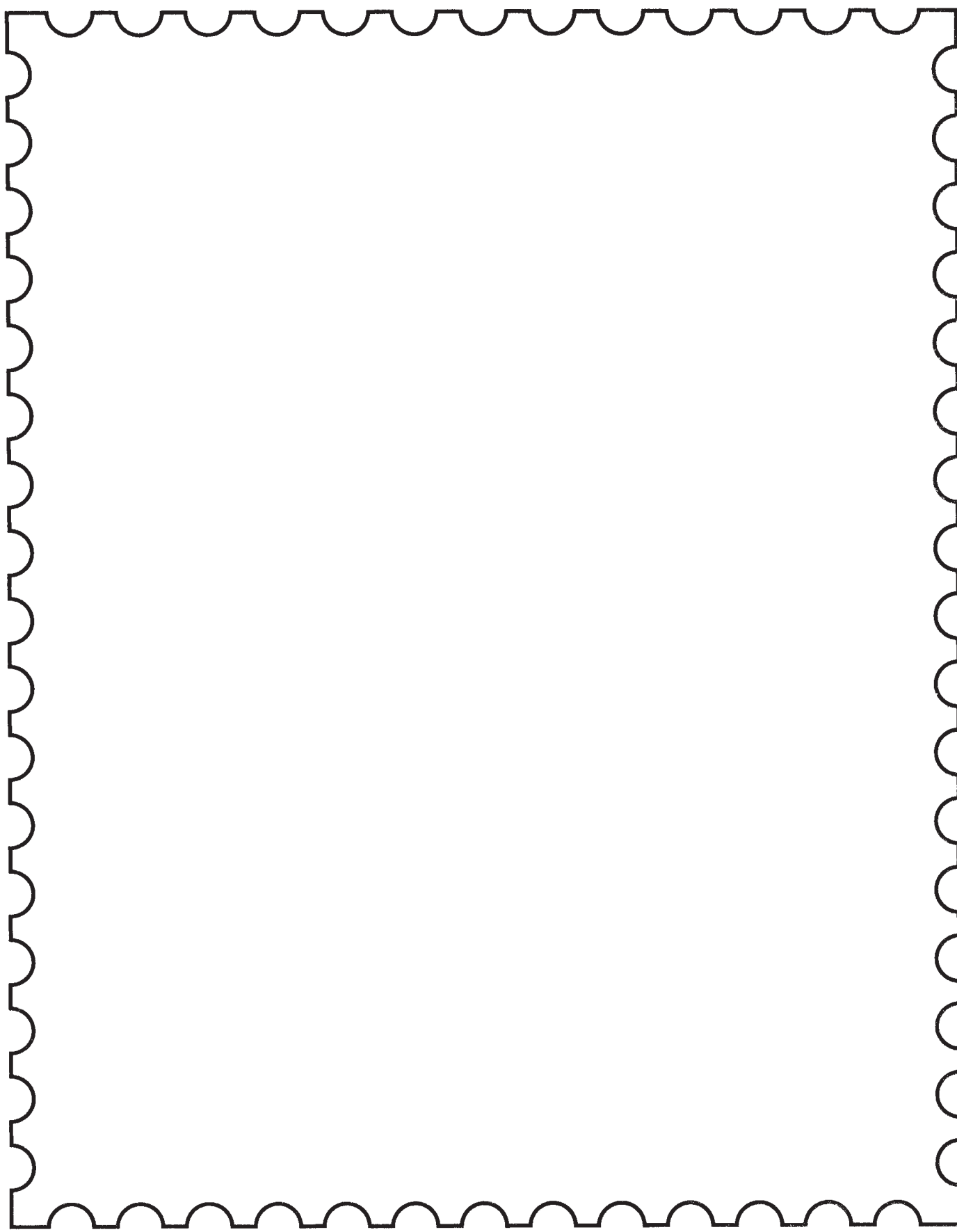

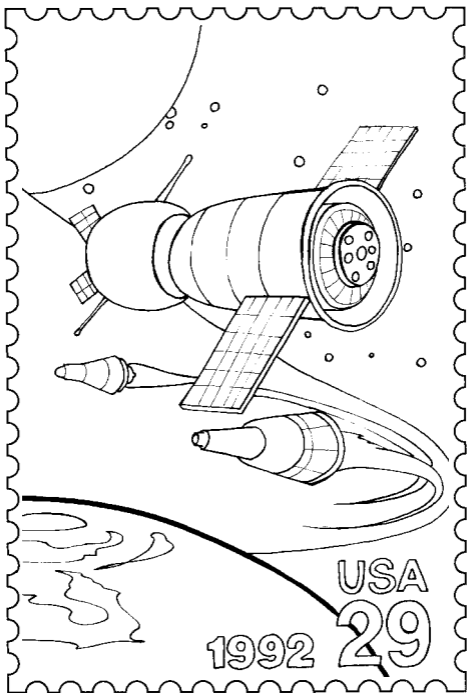

USA
1992 29

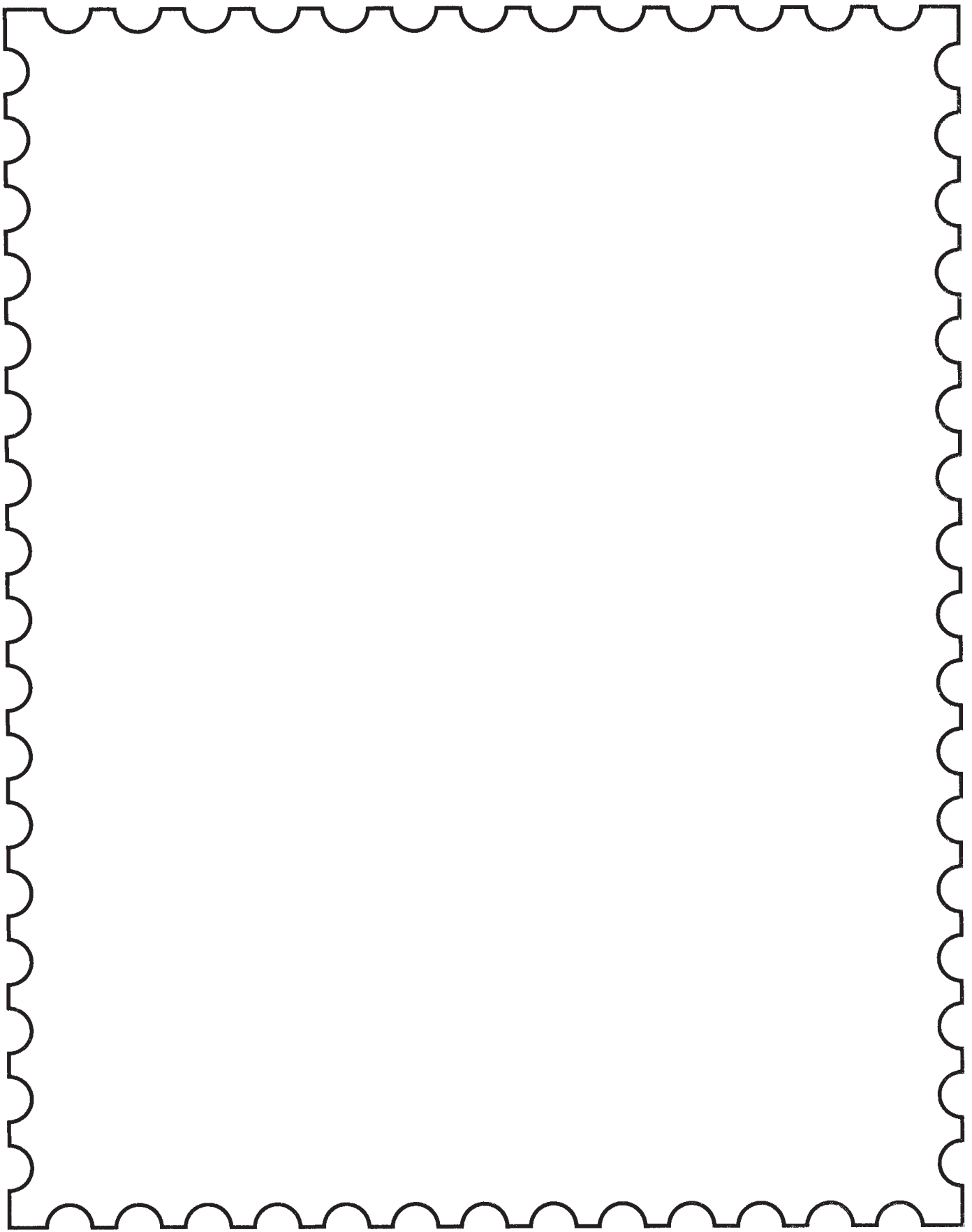

USA 18c

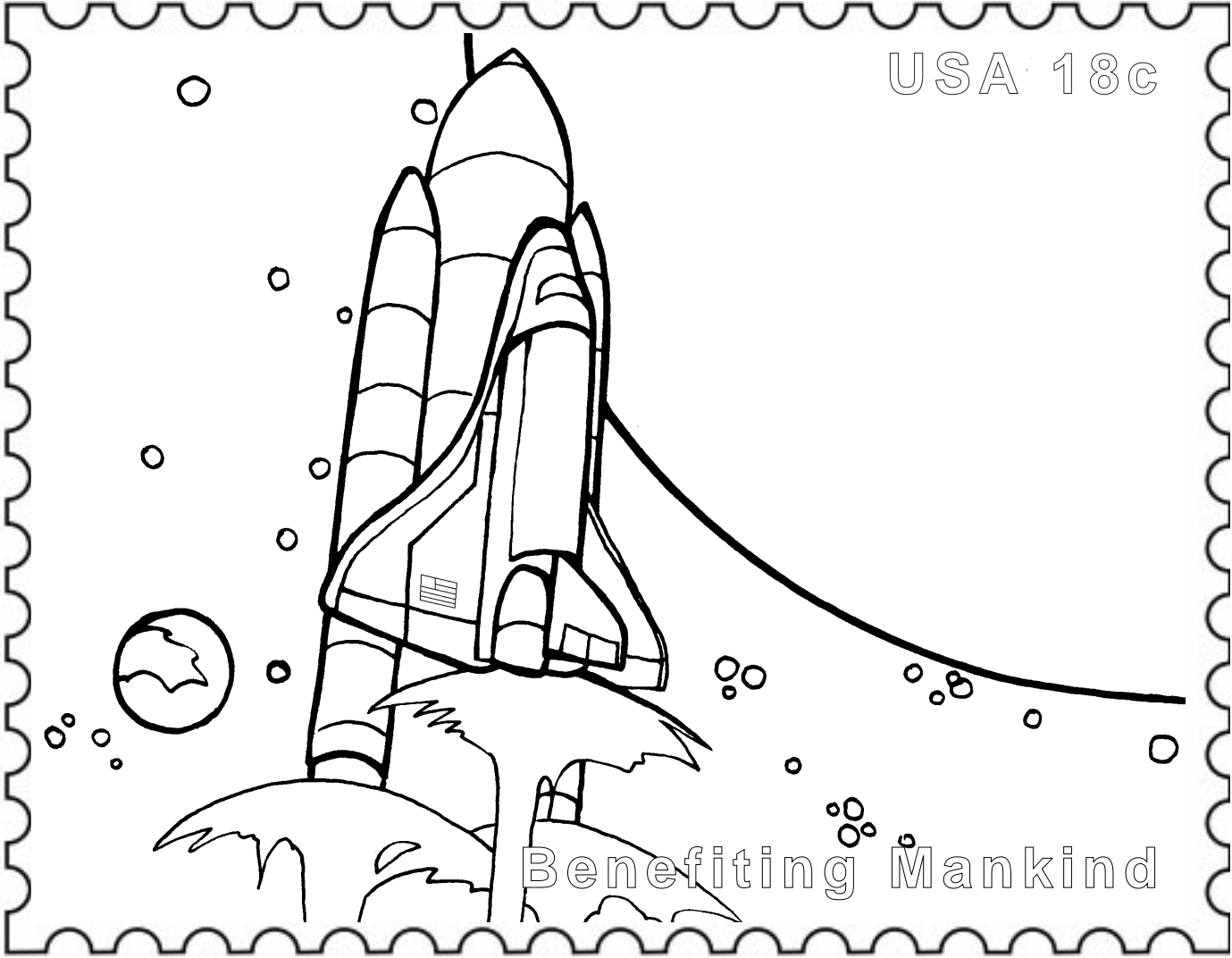

Benefiting Mankind

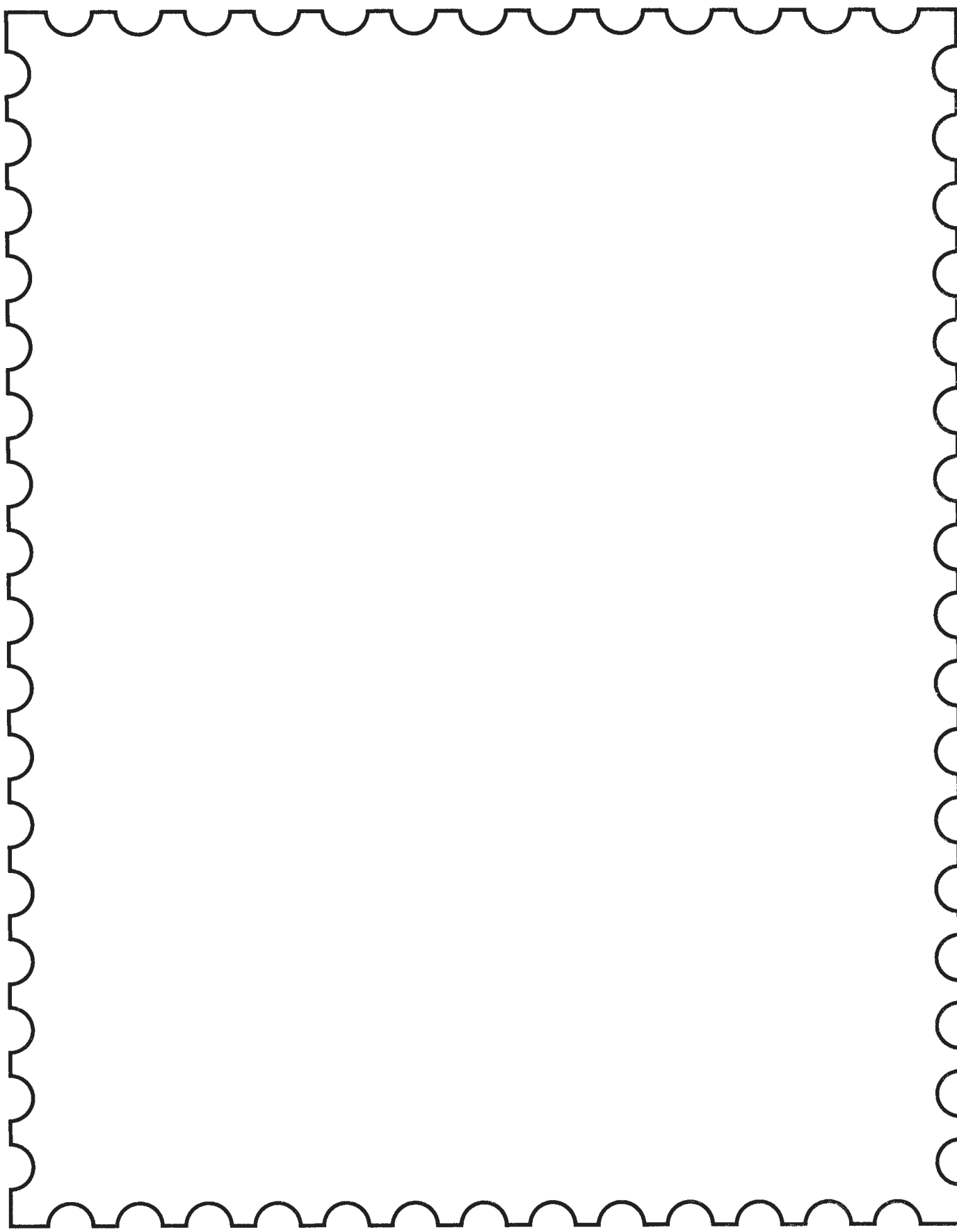

Benefiting Mankind



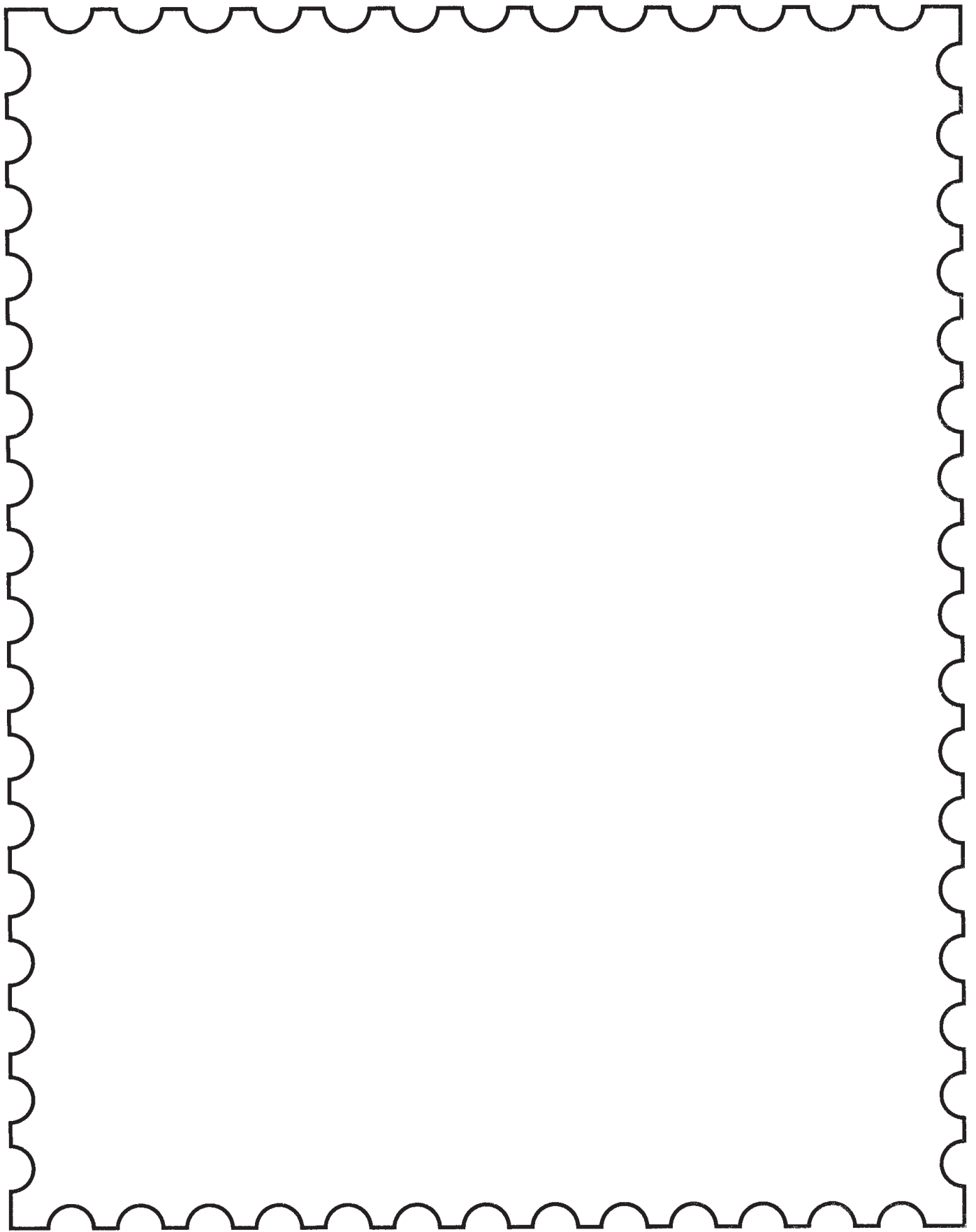

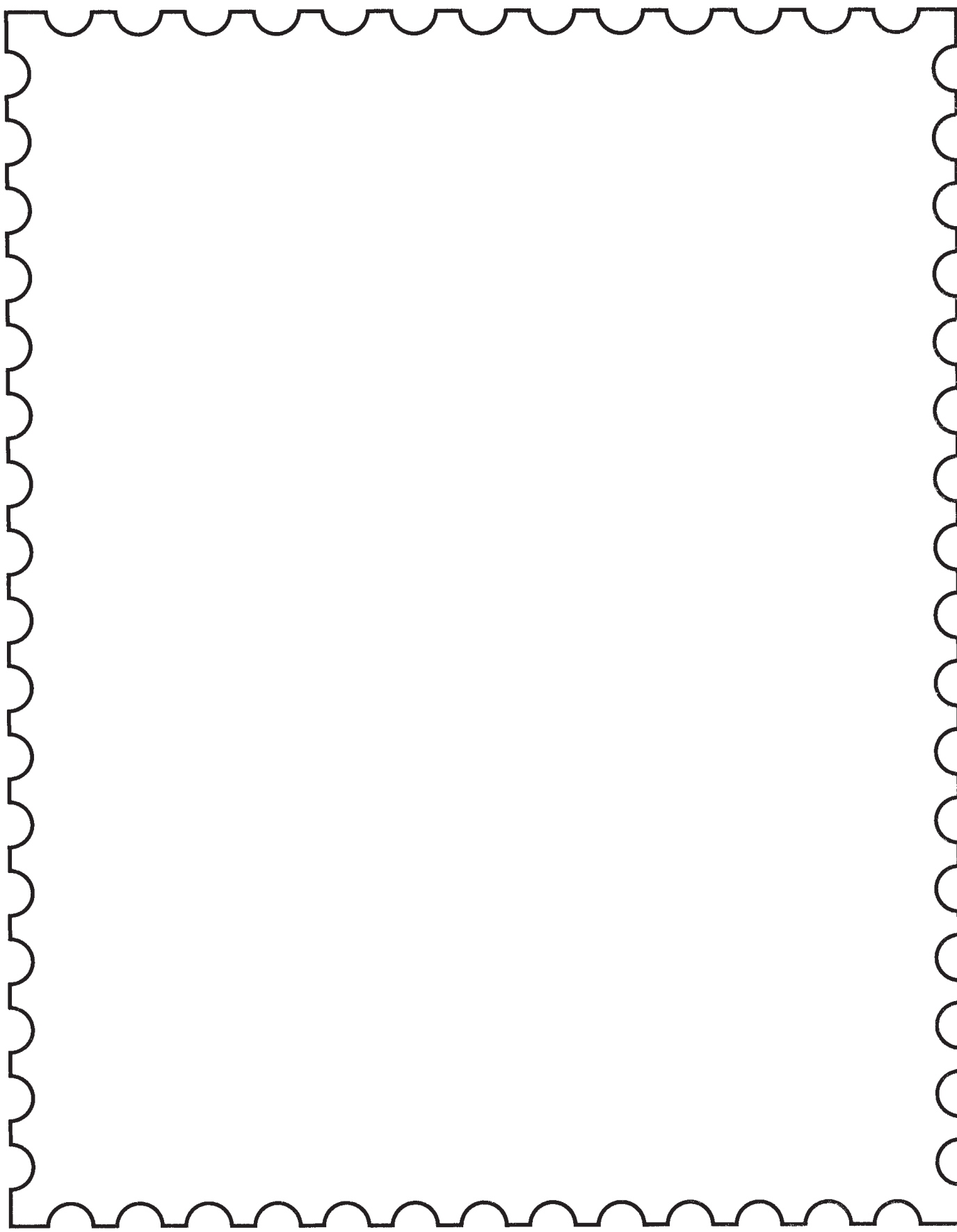

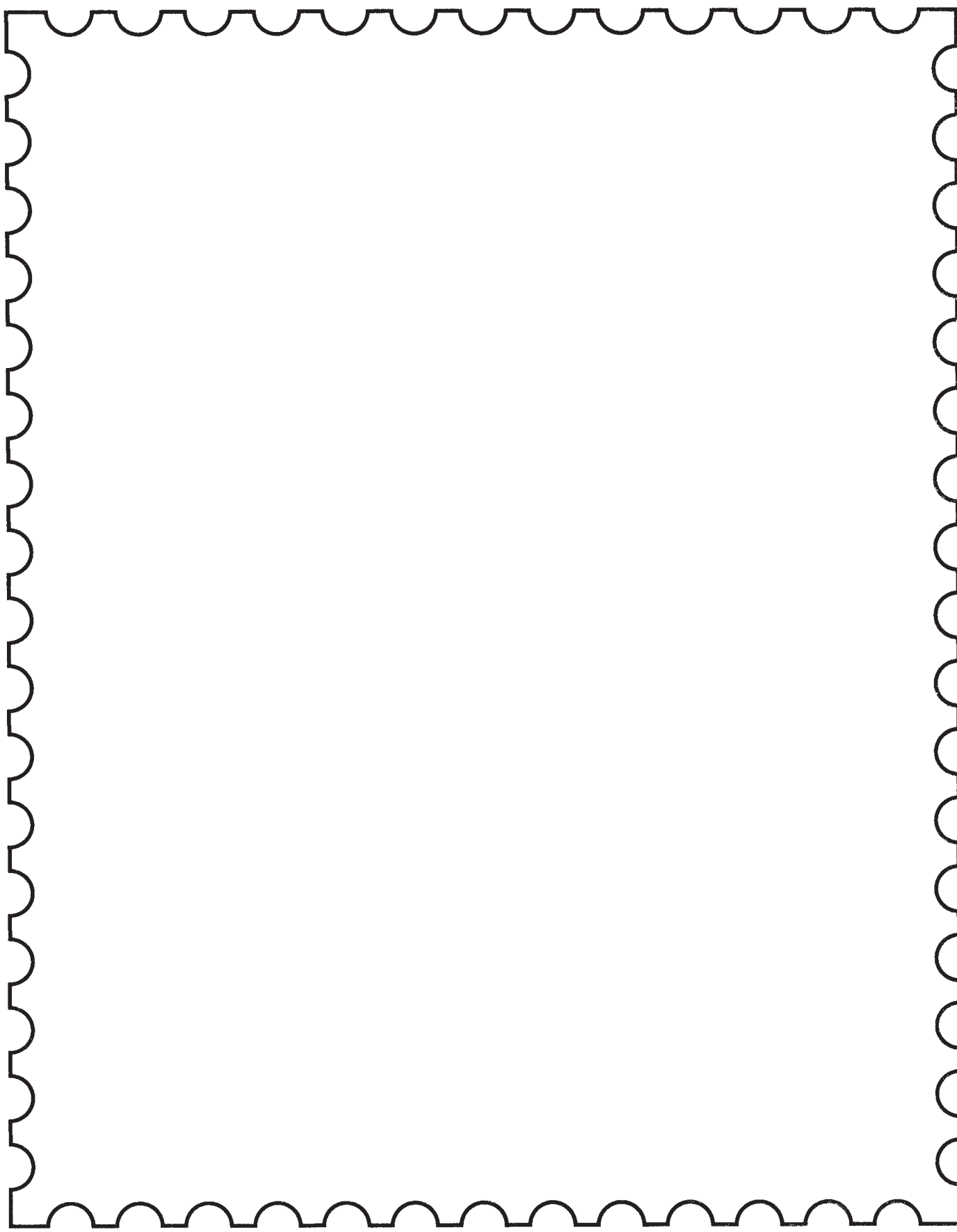

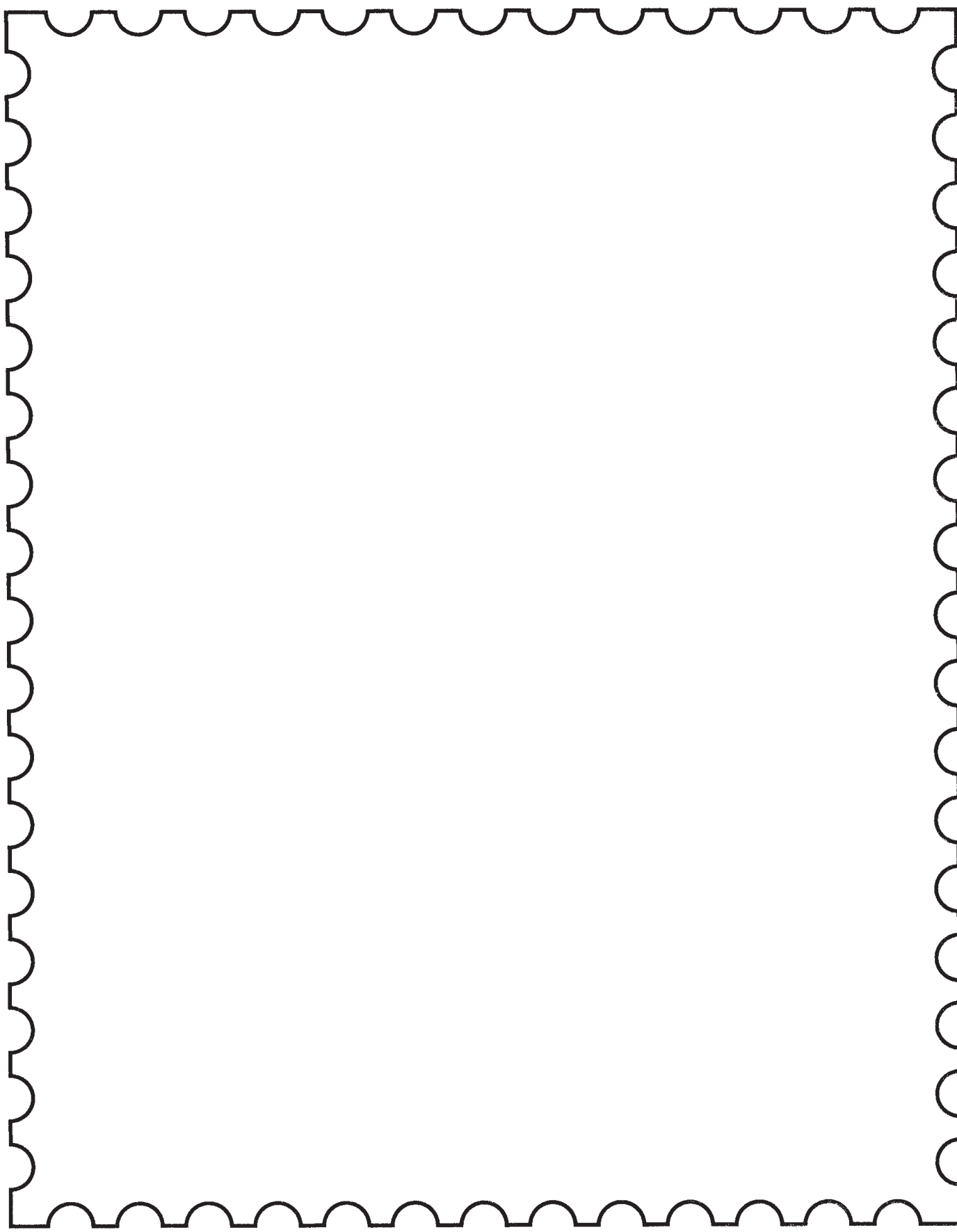

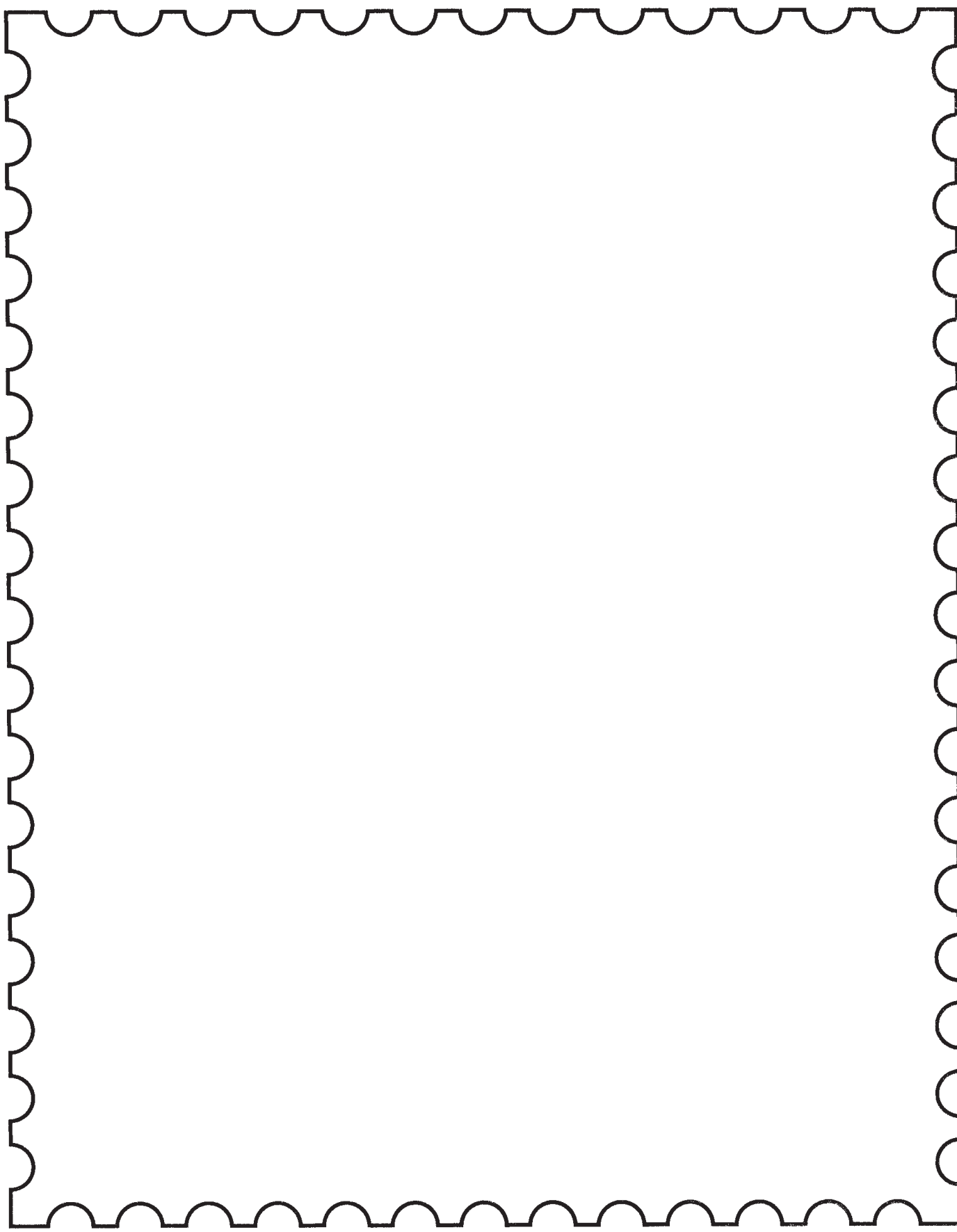

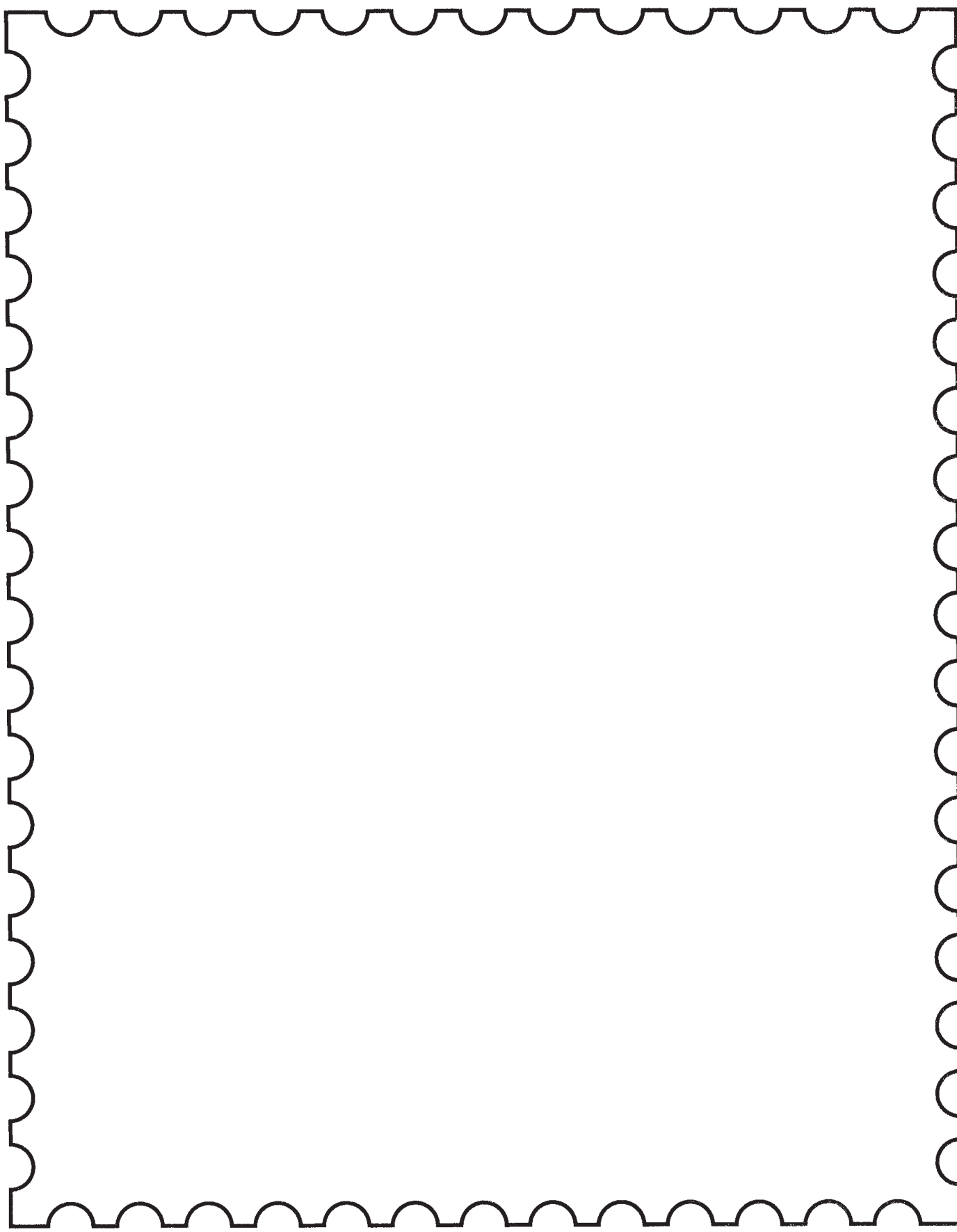

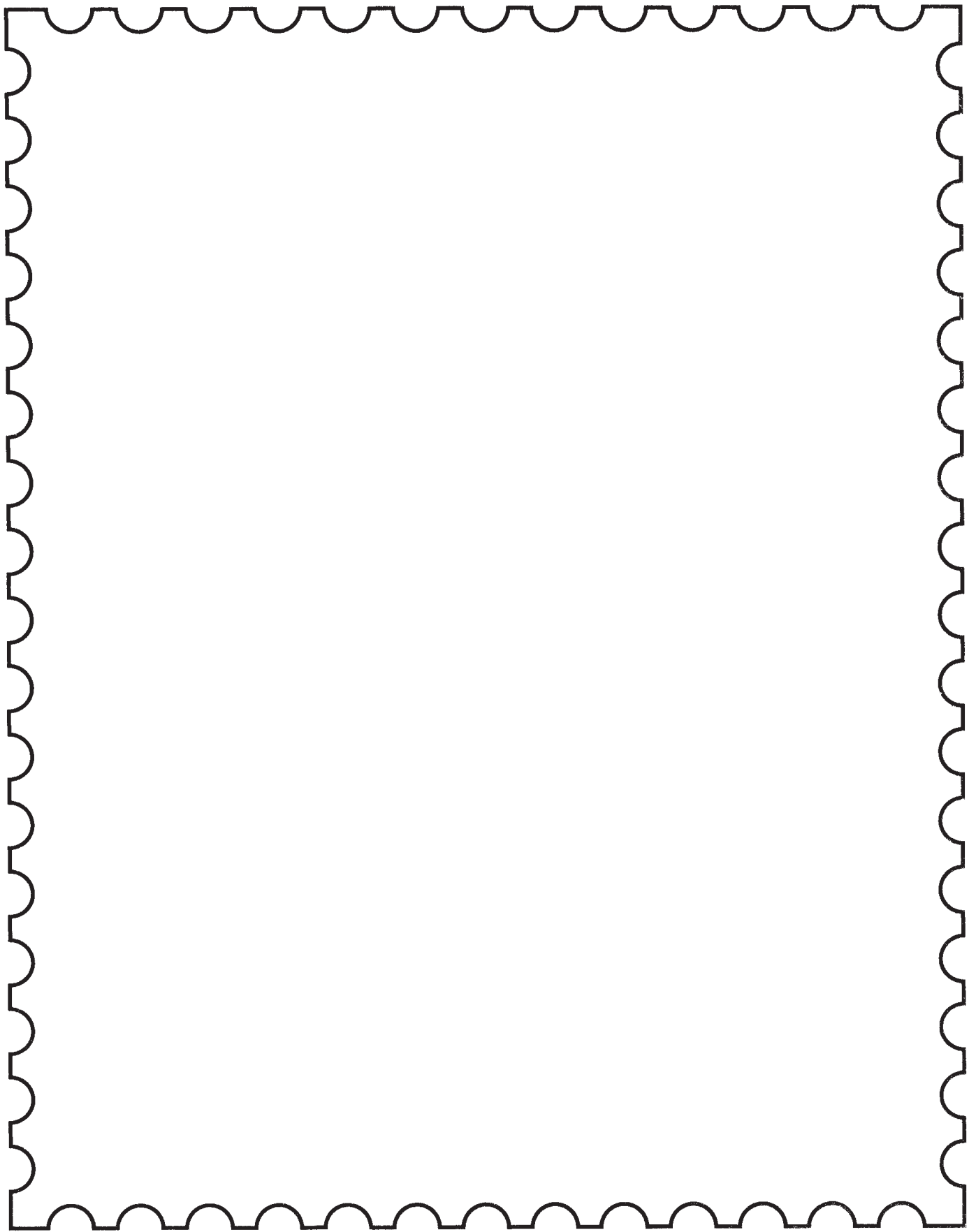

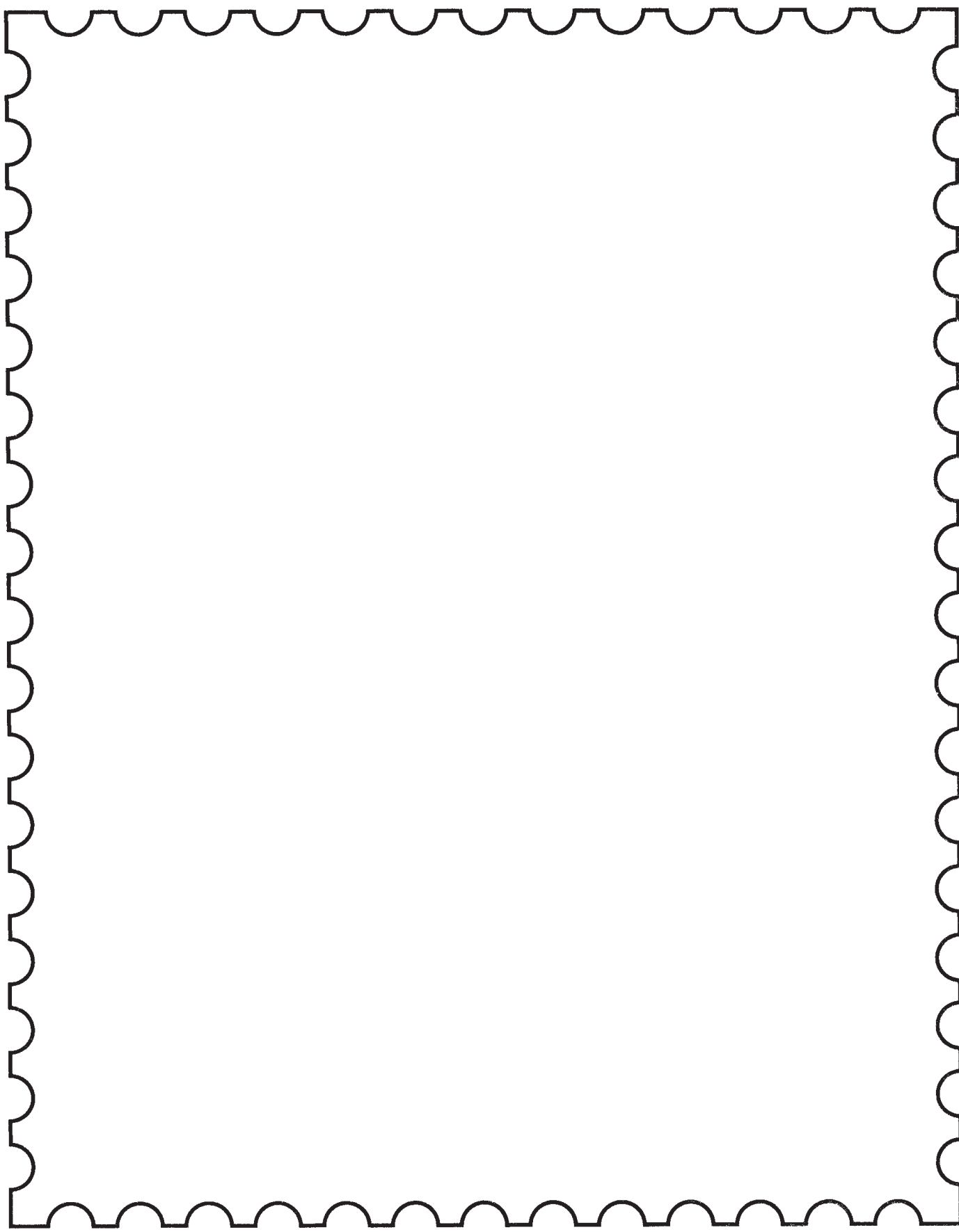

Answers

p.3 Martian Madness

Call off invasion.
Can't stand stinky human feet.

p.5 Triangle Trek

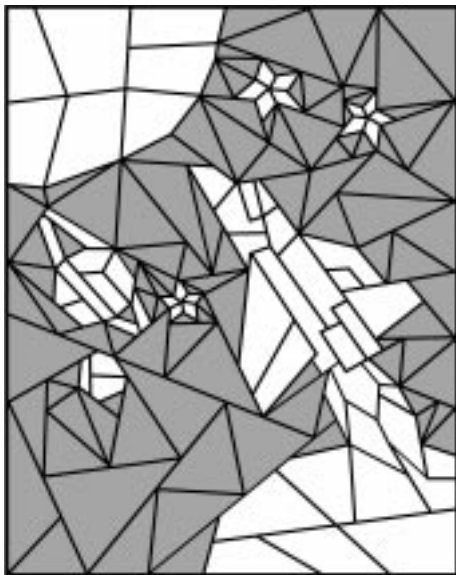

p.7 What's Your Constellation?

Constellation Canis Major

You're looking at Canis Major, the supreme pup of the night sky. It's especially playful in winter. If you look at its collar, you'll see Sirius, the "Dog Star"—the brightest of all stars.

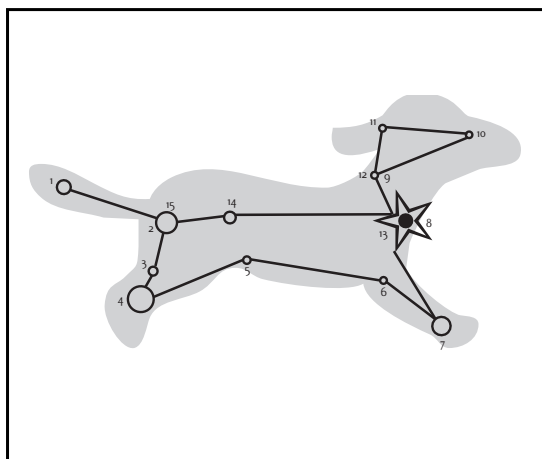

p.9 Twin Aliens

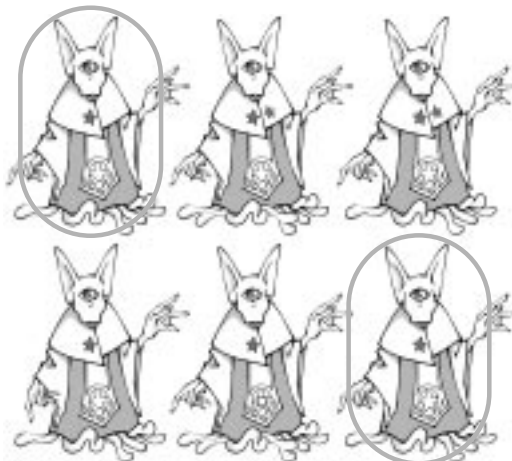

p.11 Monitor Mishaps

I'm sorry friend, I put jam in your jammies.

p.13 Ye Olde Time Warp

verily, thy, whence, thither, yon, midst,
anon, ye, livery, thrice, yeoman, consisteth,
byways, spy, forthwith, ye, knave, purloin,
hie, portcullis, thou, wilt.

p.15 Fantastic Plastic

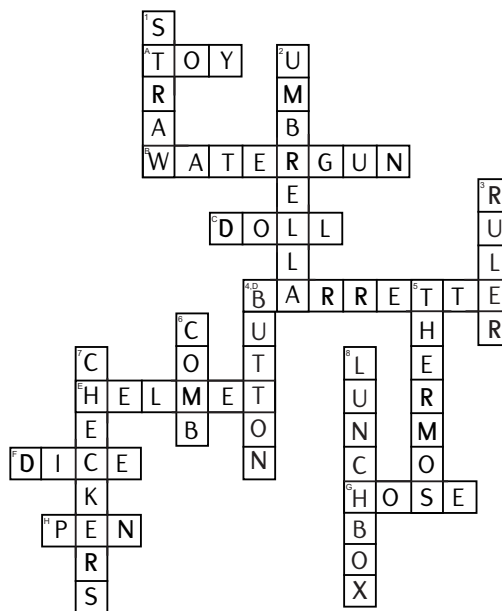

p.17 Rocket Rebuses

SPACE SHUTTLE
MARS ROVER

p.19 Revealing Missions



p.21 Alien Odyssey



p.23 A Moon's Eye View

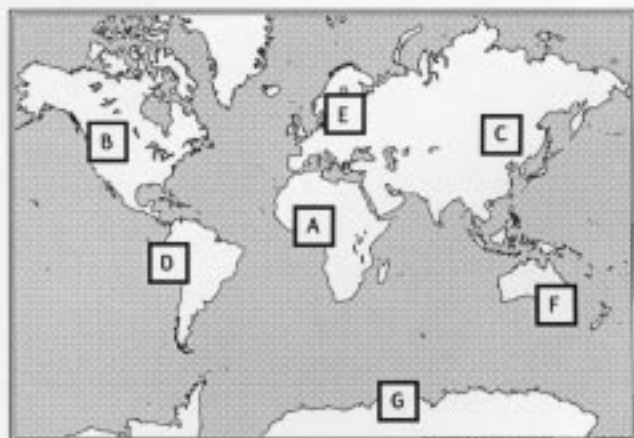

p.25 The Mailmen in the Moon

$45¢ + 32¢ + 32¢ + 29¢ + 5¢ = \1.43

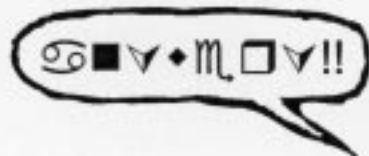

p.29 Out of Orbit

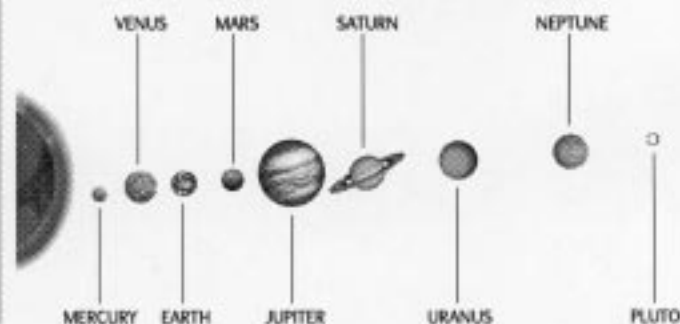





Publication 39